

Hypertherm[®]

Powermax30[®] AIR

Plasma Arc Cutting System with Integrated Air Compressor



Operator Manual

808840 | Revision 5 | English

Register your new Hypertherm system

Benefits of registration

- Safety:** Registration allows us to contact you in the unlikely event a safety or quality notification is required.
- Education:** Registration gives you free access to online product training content via the Hypertherm Cutting Institute.
- Confirmation of ownership:** Registration can serve as proof of purchase in case of an insurance loss.

Go to www.hypertherm.com/registration for easy and fast registration.

If you experience any problems with the product registration process, please contact registration@hypertherm.com.

For your records

Serial number: _____

Purchase date: _____

Distributor: _____

Maintenance notes: _____

Powermax and Hypertherm are trademarks of Hypertherm, Inc. and may be registered in the United States and other countries. All other trademarks are the property of their respective holders.

Environmental stewardship is one of Hypertherm's core values, and it is critical to our success and our customers' success. We are striving to reduce the environmental impact of everything we do. For more information: www.hypertherm.com/environment.

Powermax30 AIR

Operator Manual

808840
Revision 5

English

April 2022

Hypertherm, Inc.
Hanover, NH 03755 USA
www.hypertherm.com

Hypertherm, Inc.

21 Great Hollow Road, P.O. Box 5010
Hanover, NH 03755 USA
603-643-3441 Tel (Main Office)
603-643-5352 Fax (All Departments)
info@hypertherm.com (Main Office)

800-643-9878 Tel (Technical Service)

technical.service@hypertherm.com (Technical Service)

800-737-2978 Tel (Customer Service)

customer.service@hypertherm.com (Customer Service)

Hypertherm México, S.A. de C.V.

52 55 5681 8109 Tel
52 55 5681 7978 Tel
soporte.tecnico@hypertherm.com (Technical Service)

Hypertherm Plasmatechnik GmbH

Sophie-Scholl-Platz 5
63452 Hanau
Germany
00 800 33 24 97 37 Tel
00 800 49 73 73 29 Fax

31 (0) 165 596900 Tel (Technical Service)**00 800 4973 7843 Tel (Technical Service)**

technicalservice.emeia@hypertherm.com (Technical Service)

Hypertherm (Singapore) Pte Ltd.

Solaris @ Kallang 164
164 Kallang Way #03-13
Singapore 349248, Republic of Singapore
65 6841 2489 Tel
65 6841 2490 Fax
marketing.asia@hypertherm.com (Marketing)
techsupportapac@hypertherm.com (Technical Service)

Hypertherm Japan Ltd.

Level 9, Edobori Center Building
2-1-1 Edobori, Nishi-ku
Osaka 550-0002 Japan
81 6 6225 1183 Tel
81 6 6225 1184 Fax
htjapan.info@hypertherm.com (Main Office)
techsupportapac@hypertherm.com (Technical Service)

Hypertherm Europe B.V.

Vaartveld 9, 4704 SE
Roosendaal, Nederland
31 165 596907 Tel
31 165 596901 Fax
31 165 596908 Tel (Marketing)
31 (0) 165 596900 Tel (Technical Service)
00 800 4973 7843 Tel (Technical Service)
technicalservice.emeia@hypertherm.com (Technical Service)

Hypertherm (Shanghai) Trading Co., Ltd.

B301, 495 ShangZhong Road
Shanghai, 200231
PR China

86-21-80231122 Tel

86-21-80231120 Fax

86-21-80231128 Tel (Technical Service)

techsupport.china@hypertherm.com (Technical Service)

South America & Central America: Hypertherm Brasil Ltda.

Rua Bras Cubas, 231 – Jardim Maia
Guarulhos, SP – Brasil
CEP 07115-030
55 11 2409 2636 Tel
tecnico.sa@hypertherm.com (Technical Service)

Hypertherm Korea Branch

#3904. APEC-ro 17. Heaundae-gu. Busan.
Korea 48060
82 (0)51 747 0358 Tel
82 (0)51 701 0358 Fax
marketing.korea@hypertherm.com (Marketing)
techsupportapac@hypertherm.com (Technical Service)

Hypertherm Pty Limited

GPO Box 4836
Sydney NSW 2001, Australia
61 7 3103 1695 Tel
61 7 3219 9010 Fax
au.sales@hypertherm.com (Main Office)
techsupportapac@hypertherm.com (Technical Service)

Hypertherm (India) Thermal Cutting Pvt. Ltd

A-18 / B-1 Extension,
Mohan Co-Operative Industrial Estate,
Mathura Road, New Delhi 110044, India
91-11-40521201/ 2/ 3 Tel
91-11 40521204 Fax
htindia.info@hypertherm.com (Main Office)
technicalservice.emeia@hypertherm.com (Technical Service)



For training and education resources, go to the Hypertherm Cutting Institute (HCI) online at www.hypertherm.com/hci.

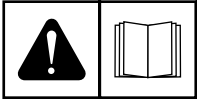

ENGLISH

WARNING! Before operating any Hypertherm equipment, read the safety instructions in your product's manual, the *Safety and Compliance Manual* (80669C), *Waterjet Safety and Compliance Manual* (80943C), and *Radio Frequency Warning Manual* (80945C). Failure to follow safety instructions can result in personal injury or in damage to equipment.

Copies of the manuals can come with the product in electronic and printed formats. Electronic copies are also on our website. Many manuals are available in multiple languages at www.hypertherm.com/docs.

BG (БЪЛГАРСКИ/BULGARIAN)

ПРЕДУПРЕЖДЕНИЕ! Преди да работите с което и да е оборудване Hypertherm, прочетете инструкциите за безопасност в ръководството на вашия продукт, „Инструкция за безопасност и съответствие“ (80669C), „Инструкция за безопасност и съответствие на Waterjet“ (80943C) и „Инструкция за предупреждение за радиочестота“ (80945C).

Продуктът може да е съпроводен от копия на ръководствата в електронен и в печатен формат. Тези в електронен формат са достъпни също на уебсайта ни. Много ръководства са налице на няколко езика на адрес www.hypertherm.com/docs.

CS (ČESKY/CZECH)

VAROVÁNÍ! Před uvedením jakéhokoli zařízení Hypertherm do provozu si přečtěte bezpečnostní pokyny v příručce k produktu a v *Manuálu pro bezpečnost a dodržování předpisů* (80669C), *Manuálu pro bezpečnost a dodržování předpisů při řezání vodním paprskem* (80943C) a *Manuálu varování ohledně rádiových frekvencí* (80945C).

Kopie příruček mohou být součástí dodávky produktu, a to v elektronické i tištěné formě. Elektronické kopie jsou k dispozici i na našich webových stránkách. Mnoho příruček je k dispozici v různých jazycích na stránce www.hypertherm.com/docs.

DA (DANSK/DANISH)

ADVARSEL! Inden Hypertherm udstyr tages i brug skal sikkerhedsinstruktionerne i produktets manual og i *Manual om sikkerhed og overholdelse af krav* (80669C), *Manual om sikkerhed og overholdelse af krav for vandstråleskæring* (80943C), og *Manual om radiofrekvensadværelse* (80945C), gennemlæses.

Kopier af manualerne kan leveres med produktet i elektronisk og trykt format. Elektroniske kopier findes også på vores hjemmeside. Mange manualer er tilgængelige på flere sprog på www.hypertherm.com/docs.

DE (DEUTSCH/GERMAN)

WARNUNG! Bevor Sie ein Hypertherm-Gerät in Betrieb nehmen, lesen Sie bitte die Sicherheitsanweisungen in Ihrer Bedienungsanleitung, das *Handbuch für Sicherheit und Übereinstimmung* (80669C), das *Handbuch für Sicherheit und Compliance bei Wasserstrahl-Schneidanlagen* (80943C) und das *Handbuch für Hochfrequenz-Warnung* (80945C).

Bedienungsanleitungen und Handbücher können dem Gerät in elektronischer Form oder als Druckversion beiliegen. In elektronischer Form liegen sie auch auf unserer Website vor. Viele Handbücher stehen in verschiedenen Sprachen auf www.hypertherm.com/docs zur Verfügung.

ES (ESPAÑOL/SPANISH)

¡ADVERTENCIA! Antes de operar cualquier equipo Hypertherm, lea las instrucciones de seguridad del manual de su producto, del *Manual de seguridad y cumplimiento* (80669C), del *Manual de seguridad y cumplimiento en corte con chorro de agua* (80943C) y del *Manual de advertencias de radiofrecuencia* (80945C).

El producto puede incluir copias de los manuales en formato digital e impreso. Las copias digitales también están en nuestra página web. Hay diversos manuales disponibles en varios idiomas en www.hypertherm.com/docs.

ET (EESTI/ESTONIAN)

HOIATUS! Enne Hyperthermi mis tahes seadme kasutamist lugege läbi toote kasutusjuhendis olevad ohutusjuhendid ning *Ohutus- ja vastavusjuhend* (80669C), *Veejoo ohutuse ja vastavuse juhend* (80943C) ja *Raadiosageduse hoiatusjuhend* (80945C). Ohutusjuhiste eiramine võib põhjustada vigastusi ja kahjustada seadmeid.

Juhiste koopiad võivad tootega kaasas olla elektrooniliselt või trükituna. Elektroonilised koopiad on saadaval ka meie veebilehel. Paljud kasutusjuhendid on erinevates keeltes saadaval veebilehel www.hypertherm.com/docs.

FI (SUOMI/FINNISH)

VAROITUS! Ennen minkään Hypertherm-laitteen käyttöä lue tuotteen käyttöoppaassa olevat turvallisuusohjeet, *turvallisuuden ja vaatimustenmukaisuuden käsikirja* (80669C), *vesileikkauksen turvallisuuden ja vaatimustenmukaisuuden käsikirja* (80943C) ja *radiotaajuusvaroitusten käsikirja* (80945C).

Käyttöoppaiden kopiot voivat olla tuotteen mukana sähköisessä ja tulostetussa muodossa. Sähköiset kopiot ovat myös verkkosivustollamme. Monet käyttöoppaat ovat myös saatavissa useilla kielillä www.hypertherm.com/docs.

FR (FRANÇAIS/FRENCH)

AVERTISSEMENT! Avant d'utiliser tout équipement Hypertherm, lire les consignes de sécurité du manuel de votre produit, du *Manuel de sécurité et de conformité* (80669C), du *Manuel de sécurité et de conformité du jet d'eau* (80943C) et du *Manuel d'avertissement relatif aux radiofréquences* (80945C).

Les exemplaires des manuels qui accompagnent le produit peuvent être sous forme électronique ou papier. Les manuels sous forme électronique se trouvent également sur notre site Internet. Plusieurs manuels sont offerts en plusieurs langues à www.hypertherm.com/docs.

GR (ΕΛΛΗΝΙΚΑ/GREEK)

ΠΡΟΕΙΔΟΠΟΙΗΣΗ! Πριν θέσετε σε λειτουργία οποιονδήποτε εξοπλισμό της Hypertherm, διαβάστε τις οδηγίες ασφαλείας στο εγχειρίδιο του προϊόντος και στο *εγχειρίδιο ασφαλείας και συμμόρφωσης* (80669C), στο *εγχειρίδιο ασφαλείας και συμμόρφωσης του waterjet* (80943C) και στο *εγχειρίδιο προειδοποιήσεων για τις ραδιοσυχνότητες* (80945C).

Το προϊόν μπορεί να συνοδεύεται από αντίγραφα των εγχειριδίων σε ηλεκτρονική και έντυπη μορφή. Τα ηλεκτρονικά αντίγραφα υπάρχουν επίσης στον ιστότοπό μας. Πολλά εγχειρίδια είναι διαθέσιμα σε διάφορες γλώσσες στο www.hypertherm.com/docs.

HU (MAGYAR/HUNGARIAN)

VIGYÁZAT! Mielőtt bármilyen Hypertherm berendezést üzemeltetne, olvassa el a biztonsági információkat a termék kézikönyvében, a *Biztonsági és szabálykövetési kézikönyvben* (80669C), a *Vízugaras biztonsági és szabálykövetési kézikönyvben* (80943C) és a *Rádiófrekvenciás figyelmeztetéseket tartalmazó kézikönyvben* (80945C).

A termékhez a kézikönyv példányai elektronikus és nyomtatott formában is mellékelve lehetnek. Az elektronikus példányok webhelyünkön is megtalálhatók. Számos kézikönyv áll rendelkezésre több nyelven a www.hypertherm.com/docs weboldalon.

ID (BAHASA INDONESIA/INDONESIAN)

PERINGATAN! Sebelum mengoperasikan peralatan Hypertherm, bacalah petunjuk keselamatan dalam manual produk Anda, *Manual Keselamatan dan Kepatuhan* (80669C), *Manual Keselamatan dan Kepatuhan Jet Air* (80943C), dan *Manual Peringatan Frekuensi Radio* (80945C). Kegagalan mengikuti petunjuk keselamatan dapat menyebabkan cedera pribadi atau kerusakan pada peralatan.

Produk mungkin disertai salinan manual atau petunjuk dalam format elektronik maupun cetak. Salinan elektronik juga tersedia di situs web kami. Berbagai manual tersedia dalam beberapa bahasa di www.hypertherm.com/docs.

IT (ITALIANO/ITALIAN)

AVVERTENZA! Prima di usare un'attrezzatura Hypertherm, leggere le istruzioni sulla sicurezza nel manuale del prodotto, nel *Manuale sulla sicurezza e la conformità* (80669C), nel *Manuale sulla sicurezza e la conformità Waterjet* (80943C) e nel *Manuale di avvertenze sulla radiofrequenza* (80945C).

Copie del manuale possono accompagnare il prodotto in formato cartaceo o elettronico. Le copie elettroniche sono disponibili anche sul nostro sito web. Molti manuali sono disponibili in diverse lingue all'indirizzo www.hypertherm.com/docs.

JA (日本語/JAPANESE)

警告! Hypertherm 機器を操作する前に、この製品説明書にある安全情報、「安全とコンプライアンスマニュアル」(80669C)、「ウォータージェット的安全とコンプライアンス」(80943C)、「高周波警告」(80945C)をお読みください。

説明書のコピーは、電子フォーマット、または印刷物として製品に同梱されています。電子コピーは当社ウェブサイトにも掲載されています。説明書の多くは www.hypertherm.com/docs にて複数の言語でご用意しています。

KO (한국어/KOREAN)

경고! Hypertherm 장비를 사용하기 전에 제품 설명서와 안전 및 규정 준수 설명서(80669C), 워터젯 안전 및 규정 준수 설명서(80943C) 그리고 무선 주파수 경고 설명서(80945C)에 나와 있는 안전 지침을 읽으십시오.

전자 형식과 인쇄된 형식으로 설명서 사본이 제품과 함께 제공될 수 있습니다. 전자 사본도 Hypertherm 웹사이트에서 보실 수 있으며 설명서 사본은 www.hypertherm.com/docs 에서 여러 언어로 제공됩니다.

NE (NEDERLANDS/DUTCH)

WAARSCHUWING! Lees voordat u Hypertherm-apparaat gebruikt de veiligheidsinstructies in de producthandleiding, in de *Veiligheids- en nalevingshandleiding* (80669C) in de *Veiligheids- en nalevingshandleiding voor waterstralen* (80943C) en in de *Waarschuwingshandleiding radiofrequentie* (80945C).

De handleidingen kunnen in elektronische en gedrukte vorm met het product worden meegeleverd. Elektronische versies zijn ook beschikbaar op onze website. Veel handleidingen zijn in meerdere talen beschikbaar via www.hypertherm.com/docs.

NO (NORSK/NORWEGIAN)

ADVARSEL! Før du bruker noe Hypertherm-utstyr, må du lese sikkerhetsinstruksjonene i produktets håndbok, *håndboken om sikkerhet og samsvar* (80669C), *håndboken om vannjet sikkerhet og samsvar* (80943C), og *håndboken om radiofrekvensadvarslere* (80945C).

Eksemplarer av håndbøkene kan følge med produktet i elektronisk og trykt form. Elektroniske eksemplarer finnes også på nettstedet vårt. Mange håndbøker er tilgjengelig i flere språk på www.hypertherm.com/docs.

PL (POLSKI/POLISH)

OSTRZEŻENIE! Przed rozpoczęciem obsługi jakiegokolwiek systemu firmy Hypertherm należy się zapoznać z instrukcjami bezpieczeństwa zamieszczonymi w podręczniku produktu, w *podręczniku bezpieczeństwa i zgodności* (80669C), *podręczniku bezpieczeństwa i zgodności systemów strumienia wody* (80943C) oraz *podręczniku z ostrzeżeniem o częstotliwości radiowej* (80945C).

Do produktu mogą być dołączone podręczniki użytkownika w formie elektronicznej i drukowanej. Kopie elektroniczne znajdują się również w naszej witrynie internetowej. Wiele podręczników jest dostępnych w różnych językach pod adresem www.hypertherm.com/docs.

PT (PORTUGUÊS/PORTUGUESE)

ADVERTÊNCIA! Antes de operar qualquer equipamento Hypertherm, leia as instruções de segurança no manual do seu produto, no *Manual de Segurança e de Conformidade* (80669C), no *Manual de Segurança e de Conformidade do Waterjet* (80943C) e no *Manual de Advertência de radiofrequência* (80945C).

Cópias dos manuais podem vir com o produto nos formatos eletrônico e impresso. Cópias eletrônicas também são encontradas em nosso website. Muitos manuais estão disponíveis em vários idiomas em www.hypertherm.com/docs.

RO (ROMÂNĂ/ROMANIAN)

AVERTIZARE! Înainte de utilizarea oricărei echipament Hypertherm, citiți instrucțiunile de siguranță din manualul produsului, *manualul de siguranță și conformitate* (80669C), *manualul de siguranță și conformitate Waterjet* (80943C) și din *manualul de avertizare privind radiofrecvența* (80945C).

Produsul poate fi însoțit de copii ale manualelor în format tipărit și electronic. Exemplarele electronice sunt disponibile și pe site-ul nostru web. Numeroase manuale sunt disponibile în mai mult limbi la adresa: www.hypertherm.com/docs.

RU (РУССКИЙ/RUSSIAN)

БЕРЕГИТЬСЯ! Перед работой с любым оборудованием Hypertherm ознакомьтесь с инструкциями по безопасности, представленными в руководстве, которое поставляется вместе с продуктом, в *Руководстве по безопасности и соответствию* (80669C), в *Руководстве по безопасности и соответствию для водоструйной резки* (80943C) и *Руководстве по предупреждению о радиочастотном излучении* (80945C).

Копии руководств, которые поставляются вместе с продуктом, могут быть представлены в электронном и бумажном виде. Электронные копии также доступны на нашем веб-сайте. Целый ряд руководств доступны на нескольких языках по ссылке www.hypertherm.com/docs.

SK (SLOVENČINA/SLOVAK)

VÝSTRAHA! Pred použitím akéhokoľvek zariadenia od spoločnosti Hypertherm si prečítajte bezpečnostné pokyny v návode na obsluhu vášho zariadenia a v *Manuáli o bezpečnosti a súlade s normami* (80669C), *Manuáli o bezpečnosti a súlade s normami pre systém rezania vodou* (80943C) a v *Manuáli s informáciami o rádiových frekvenciách* (80945C).

Návod na obsluhu sa dodáva spolu s produktom v elektronickej a tlačenej podobe. Jeho elektronický formát je dostupný aj na našej webovej stránke. Mnohé z návodov na obsluhu sú dostupné vo viacjazyčnej mutácii na stránke www.hypertherm.com/docs.

SL (SLOVENŠČINA/SLOVENIAN)

OPOZORILO! Pred uporabo katerekoli Hyperthermove opreme preberite varnostna navodila v priročniku vašega izdelka, v *Priročniku za varnost in skladnost* (80669C), v *Priročniku za varnost in skladnost sistemov rezanja z vodnim curkom* (80943C) in v *Priročniku Opozorilo o radijskih frekvencah* (80945C).

Izvodi priročnikov so lahko izdelku priloženi v elektronski in tiskani obliki. Elektronski izvodi so na voljo tudi na našem spletnem mestu. Številni priročniki so na voljo v različnih jezikih na naslovu www.hypertherm.com/docs.

SR (SRPSKI/SERBIAN)

UPOZORENJE! Pre rukovanja bilo kojom Hyperthermovom opremom pročitajte uputstva o bezbednosti i svom priručniku za proizvod, *Priručniku o bezbednosti i usaglašenosti* (80669C), *Priručniku o bezbednosti i usaglašenosti Waterjet tehnologije* (80943C) i *Priručniku sa upozorenjem o radio-frekvenciji* (80945C).

Уз производ се испоручују копије приручника у електронском или штампаном формату. Електронске копије су такође доступне на нашем веб-сајту. Многи приручници су доступни на више језика на адреси www.hypertherm.com/docs.

SV (SVENSKA/SWEDISH)

VARNING! Läs häftet säkerhetsinformationen i din produkts *säkerhets- och efterlevnadsmanual* (80669C), *säkerhets- och efterlevnadsmanualen för Waterjet* (80943C) och *varningsmanualen för radiofrekvenser* (80945C) för viktig säkerhetsinformation innan du använder eller underhåller Hypertherm-utrustning. Kopior av manualerna kan medfölja produkten i elektroniskt och tryckt format. Elektroniska kopior finns också på vår webbplats. Många manualer finns på flera språk på www.hypertherm.com/docs.

TH (ภาษาไทย/THAI)

คำเตือน! ก่อนการใช้งานอุปกรณ์ของ Hypertherm ทั้งหมด โปรดอ่านคำแนะนำด้านความปลอดภัยในคู่มือการใช้งานสินค้า คู่มือด้านความปลอดภัยและการปฏิบัติตาม (80669C), คู่มือด้านความปลอดภัยและการปฏิบัติตามสำหรับการใช้หัวตัดระบบวอเตอร์เจ็ต (80943C) และ คู่มือคำเตือนเกี่ยวกับความถี่วิทยุ (80945C) การไม่ปฏิบัติตามคำแนะนำด้านความปลอดภัยอาจส่งผลให้เกิดการบาดเจ็บหรือเกิดความเสียหายต่ออุปกรณ์

สำเนาคู่มือทั้งในรูปแบบอิเล็กทรอนิกส์และแบบสิ่งพิมพ์จะถูกแนบมาพร้อมกับผลิตภัณฑ์ สำเนาคู่มือในรูปแบบอิเล็กทรอนิกส์ของผลิตภัณฑ์และสำเนาคู่มือต่าง ๆ ในหลากหลายภาษานั้นยังมีให้บริการบนเว็บไซต์ www.hypertherm.com/docs ของเรอีกด้วย

TR (TÜRKÇE/TURKISH)

UYARI! Bir Hypertherm ekipmanını çalıştırmadan önce, ürününüzün kullanım kılavuzunda, *Güvenlik ve Uyumluluk Kılavuzu'nda* (80669C), *Su Jeti Güvenlik ve Uyumluluk Kılavuzu'nda* (80943C) ve *Radio Frekanslı Uyarısı Kılavuzu'nda* (80945C) yer alan güvenlik talimatlarını okuyun.

Kılavuzların kopyaları, elektronik ve basılı formatta ürünle birlikte verilebilir. Elektronik kopyalar web sitemizde de yer alır. Kılavuzların birçoğu www.hypertherm.com/docs adresinde birçok dilde mevcuttur.

VI (TIẾNG VIỆT/VIETNAMESE)

CẢNH BÁO! Trước khi vận hành bất kỳ thiết bị Hypertherm nào, hãy đọc các hướng dẫn an toàn trong hướng dẫn sử dụng sản phẩm của bạn, *Sổ tay An toàn và Tuân thủ* (80669C), *Sổ tay An toàn và Tuân thủ Tia nước* (80943C), và *Hướng dẫn Cảnh báo Tần số Vô tuyến* (80945C). Không tuân thủ các hướng dẫn an toàn có thể dẫn đến thương tích cá nhân hoặc hư hỏng thiết bị.

Bản sao của sổ tay có thể đi kèm với sản phẩm ở định dạng điện tử và in. Bản điện tử cũng có trên trang web của chúng tôi. Nhiều sổ tay có sẵn bằng nhiều ngôn ngữ tại www.hypertherm.com/docs.

ZH-CN (简体中文/CHINESE SIMPLIFIED)

警告！在操作任何海宝设备之前，请阅读产品手册、《安全和法规遵守手册》(80669C)、《水射流安全和法规遵守手册》(80943C)以及《射频警告手册》(80945C)中的安全操作说明。

随产品提供的手册可提供电子版和印刷版两种格式。电子版本同时也在我们的网站上提供。很多手册有多种语言版本，详见 www.hypertherm.com/docs。

ZH-TW (繁體中文/CHINESE TRADITIONAL)

警告！在操作任何 Hypertherm 設備前，請先閱讀您產品手冊內的安全指示，包括《安全和法規遵從手冊》(80669C)、《水刀安全和法規遵從手冊》(80943C)，以及《無線電頻率警示訊號手冊》(80945C)。

電子版和印刷版手冊樣本可能隨產品附上。您也可以前往我們的網站下載電子版手冊。我們的網站上還以多種語言形式提供多種手冊，請造訪 www.hypertherm.com/docs。

Electromagnetic Compatibility (EMC)	SC-11
Introduction	SC-11
Installation and use	SC-11
Assessment of area	SC-11
Methods of reducing emissions	SC-11
Mains supply	SC-11
Maintenance of cutting equipment	SC-11
Cutting cables	SC-11
Equipotential bonding	SC-11
Earthing of the workpiece	SC-12
Screening and shielding	SC-12
Warranty	SC-13
Attention	SC-13
General	SC-13
Patent indemnity	SC-13
Limitation of liability	SC-13
National and local codes	SC-13
Liability cap	SC-14
Insurance	SC-14
Transfer of rights	SC-14
Waterjet product warranty coverage	SC-14
Product	SC-14
Parts coverage	SC-14
1 Specifications	15
Safety information	15
System description	15

Power supply dimensions	16
System weights	16
Hypertherm system ratings	17
Torch dimensions	18
Torch weight	18
Cutting specifications	19
IEC symbols	20
Noise levels	20
Symbols and marks	21
2 Power Supply Setup	23
Unpack the plasma system	23
Claims	23
System contents	24
Position the plasma cutting system	25
Prepare the electrical power	25
Voltage configurations	25
Requirements for grounding	27
Power cord considerations	27
CSA power cords and plugs	27
CE and CCC power cords	28
Install a plug on the power cord	28
Extension cord recommendations	29
Generator recommendations	29
3 Torch Setup	31
Introduction	31
Hand torch components	31
Consumable life	32
Consumable use	33
Using the cut charts	33
Consumable set	34
240 V / 30 A cutting	35
120 V / 20 A cutting	37
4 Operation	39
Controls and indicators	39
Rear controls	39
Front panel controls and indicator LED symbols	40
Operate the plasma system	41
Step 1 – Install the consumables	41

- Step 2 – Connect the electrical power 42
- Step 3 – Adjust the output current 43
 - Operating the system on a 120 V / 20 A circuit 43
 - Operating the system on a 240 V / 20 A circuit 43
 - Decrease output current for lower-rated power plugs 43
 - Cutting expanded metal 43
- Step 4 – Attach the ground clamp 44
- Step 5 – Power ON the system 44
- Step 6 – Check the indicator LEDs 44
- Step 7 – Make sure the system is ready, and start cutting 45
- What to expect during and after cutting 45
 - Water at the torch nozzle 45
 - Postflow 45
 - Internal compressor and fan activity 45
 - Water under the power supply 45
- Understand duty-cycle limitations 46
- System operation guidelines 47
- Hand torch operation 48
 - Safety catch operation 48
 - Hand torch cutting guidelines 49
 - Recommendations for cutting at 120 V 49
 - Edge start on a workpiece 50
 - Pierce a workpiece 51
 - Common hand-cutting faults 52
 - Minimizing dross 52
- 5 Maintenance and Troubleshooting 53**
 - Perform routine maintenance 53
 - Inspect the consumables 55
 - Basic troubleshooting 56
 - Power LED faults 56
 - Temperature LED faults 57
 - Internal compressor LED faults 58
 - Torch LED faults 59
 - Common cutting issues 60
- 6 Parts 63**
 - Power supply parts 64
 - Exterior, front 64
 - Exterior, rear 65
 - Hand torch consumables 66

Contents

Accessory parts 67

Power supply labels 68

 Consumables label 68

 CSA warning label 69

 CE/CCC warning label 70

Introduction

Hypertherm's CE-marked equipment is built in compliance with standard EN60974-10. The equipment should be installed and used in accordance with the information below to achieve electromagnetic compatibility.

The limits required by EN60974-10 may not be adequate to completely eliminate interference when the affected equipment is in close proximity or has a high degree of sensitivity. In such cases it may be necessary to use other measures to further reduce interference.

This cutting equipment is designed for use only in an industrial environment.

Installation and use

The user is responsible for installing and using the plasma equipment according to the manufacturer's instructions.

If electromagnetic disturbances are detected then it shall be the responsibility of the user to resolve the situation with the technical assistance of the manufacturer. In some cases this remedial action may be as simple as earthing the cutting circuit, see *Earthing of the workpiece*. In other cases, it could involve constructing an electromagnetic screen enclosing the power source and the work complete with associated input filters. In all cases, electromagnetic disturbances must be reduced to the point where they are no longer troublesome.

Assessment of area

Before installing the equipment, the user shall make an assessment of potential electromagnetic problems in the surrounding area. The following shall be taken into account:

- a. Other supply cables, control cables, signaling and telephone cables; above, below and adjacent to the cutting equipment.
- b. Radio and television transmitters and receivers.
- c. Computer and other control equipment.
- d. Safety critical equipment, for example guarding of industrial equipment.
- e. Health of the people around, for example the use of pacemakers and hearing aids.
- f. Equipment used for calibration or measurement.
- g. Immunity of other equipment in the environment. User shall ensure that other equipment being used in the environment is compatible. This may require additional protection measures.
- h. Time of day that cutting or other activities are to be carried out.

The size of the surrounding area to be considered will depend on the structure of the building and other activities that are taking place. The surrounding area may extend beyond the boundaries of the premises.

Methods of reducing emissions

Mains supply

Cutting equipment must be connected to the mains supply according to the manufacturer's recommendations. If interference occurs, it may be necessary to take additional precautions such as filtering of the mains supply.

Consideration should be given to shielding the supply cable of permanently installed cutting equipment, in metallic conduit or equivalent. Shielding should be electrically continuous throughout its length. The shielding should be connected to the cutting mains supply so that good electrical contact is maintained between the conduit and the cutting power source enclosure.

Maintenance of cutting equipment

The cutting equipment must be routinely maintained according to the manufacturer's recommendations. All access and service doors and covers should be closed and properly fastened when the cutting equipment is in operation. The cutting equipment should not be modified in any way, except as set forth in and in accordance with the manufacturer's written instructions. For example, the spark gaps of arc striking and stabilizing devices should be adjusted and maintained according to the manufacturer's recommendations.

Cutting cables

The cutting cables should be kept as short as possible and should be positioned close together, running at or close to the floor level.

Equipotential bonding

Bonding of all metallic components in the cutting installation and adjacent to it should be considered.

However, metallic components bonded to the workpiece will increase the risk that the operator could receive a shock by touching these metallic components and the electrode (nozzle for laser heads) at the same time.

The operator should be insulated from all such bonded metallic components.

Electromagnetic Compatibility (EMC)

Earthing of the workpiece

Where the workpiece is not bonded to earth for electrical safety, nor connected to earth because of its size and position, for example, ship's hull or building steel work, a connection bonding the workpiece to earth may reduce emissions in some, but not all instances. Care should be taken to prevent the earthing of the workpiece increasing the risk of injury to users, or damage to other electrical equipment. Where necessary, the connection of the workpiece to earth should be made by a direct connection to the workpiece, but in some countries where direct connection is not permitted, the bonding should be achieved by suitable capacitances selected according to national regulations.

Note: The cutting circuit may or may not be earthed for safety reasons. Changing the earthing arrangements should only be authorized by a person who is competent to assess whether the changes will increase the risk of injury, for example, by allowing parallel cutting current return paths which may damage the earth circuits of other equipment. Further guidance is provided in IEC 60974-9, Arc Welding Equipment, Part 9: Installation and Use.

Screening and shielding

Selective screening and shielding of other cables and equipment in the surrounding area may alleviate problems of interference. Screening of the entire plasma cutting installation may be considered for special applications.

Attention

Genuine Hypertherm parts are the factory-recommended replacement parts for your Hypertherm system. Any damage or injury caused by the use of other than genuine Hypertherm parts may not be covered by the Hypertherm warranty, and will constitute misuse of the Hypertherm Product.

You are solely responsible for the safe use of the Product. Hypertherm does not and cannot make any guarantee or warranty regarding the safe use of the product in your environment.

General

Hypertherm, Inc. warrants that its Products shall be free from defects in materials and workmanship for the specific periods of time set forth herein and as follows: if Hypertherm is notified of a defect (i) with respect to the plasma power supply within a period of two (2) years from the date of its delivery to you, with the exception of Powermax brand power supplies, which shall be within a period of three (3) years from the date of delivery to you, and (ii) with respect to the torch and leads within a period of one (1) year from its date of delivery to you, with the exception of the HPRXD short torch with integrated lead, which shall be within a period of six (6) months from the date of delivery to you, and with respect to torch lifter assemblies within a period of one (1) year from its date of delivery to you, and with respect to Automation products one (1) year from its date of delivery to you, with the exception of the EDGE Connect CNC, EDGE Connect T CNC, EDGE Connect TC CNC, EDGE Pro CNC, EDGE Pro Ti CNC, MicroEDGE Pro CNC, and ArcGlide THC, which shall be within a period of two (2) years from the date of delivery to you, and (iii) with respect to HyIntensity fiber laser components within a period of two (2) years from the date of its delivery to you, with the exception of laser heads and beam delivery cables, which shall be within a period of one (1) year from its date of delivery to you.

All third-party engines, engine accessories, alternators, and alternator accessories are covered by the respective manufacturers' warranties and not covered by this warranty.

This warranty shall not apply to any Powermax brand power supplies that have been used with phase converters. In addition, Hypertherm does not warranty systems that have been damaged as a result of poor power quality, whether from phase converters or incoming line power. This warranty shall not apply to any product which has been incorrectly installed, modified, or otherwise damaged.

Hypertherm provides repair, replacement or adjustment of the Product as the sole and exclusive remedy, if and only if the warranty set forth herein properly is invoked and applies. Hypertherm, at its sole option, shall repair, replace, or adjust, free of charge, any defective Products covered by this warranty which shall be returned with Hypertherm's prior authorization (which shall not be unreasonably withheld), properly packed, to Hypertherm's place of business in Hanover, New Hampshire, or to an authorized Hypertherm repair facility, all costs, insurance and freight pre paid by the customer. Hypertherm shall not be liable for any repairs, replacement, or adjustments of Products covered by this warranty, except those made pursuant to this paragraph and with Hypertherm's prior written consent.

The warranty set forth above is exclusive and is in lieu of all other warranties, express, implied, statutory, or otherwise with respect to the Products or as to the results which may be obtained therefrom, and all implied warranties or conditions of quality or of merchantability or fitness for a particular purpose or against infringement. The foregoing shall constitute the sole and exclusive remedy for any breach by Hypertherm of its warranty.

Distributors/OEMs may offer different or additional warranties, but Distributors/OEMs are not authorized to give any additional warranty protection to you or make any representation to you purporting to be binding upon Hypertherm.

Patent indemnity

Except only in cases of products not manufactured by Hypertherm or manufactured by a person other than Hypertherm not in strict conformity with Hypertherm's specifications and in cases of designs, processes, formulae, or combinations not developed or purported to be developed by Hypertherm, Hypertherm will have the right to defend or settle, at its own expense, any suit or proceeding brought against you alleging that the use of the Hypertherm product, alone and not in combination with any other product not supplied by Hypertherm, infringes any patent of any third party. You shall notify Hypertherm promptly upon learning of any action or threatened action in connection with any such alleged infringement (and in any event no longer than fourteen (14) days after learning of any action or threat of action), and Hypertherm's obligation to defend shall be conditioned upon Hypertherm's sole control of, and the indemnified party's cooperation and assistance in, the defense of the claim.

Limitation of liability

In no event shall Hypertherm be liable to any person or entity for any incidental, consequential direct, indirect, punitive or exemplary damages (including but not limited to lost profits) regardless of whether such liability is based on breach of contract, tort, strict liability, breach of warranty, failure of essential purpose, or otherwise, and even if advised of the possibility of such damages. Hypertherm shall not be liable for any losses to Distributor based on down time, lost production or lost profits. It is the intention of the Distributor and Hypertherm that this provision be construed by a court as being the broadest limitation of liability consistent with applicable law.

National and local codes

National and local codes governing plumbing and electrical installation shall take precedence over any instructions contained in this manual. In no event shall Hypertherm be liable for injury to persons or property damage by reason of any code violation or poor work practices.

Warranty

Liability cap

In no event shall Hypertherm's liability, if any, whether such liability is based on breach of contract, tort, strict liability, breach of warranties, failure of essential purpose or otherwise, for any claim, action, suit or proceeding (whether in court, arbitration, regulatory proceeding or otherwise) arising out of or relating to the use of the Products exceed in the aggregate the amount paid for the Products that gave rise to such claim.

Insurance

At all times you will have and maintain insurance in such quantities and types, and with coverage sufficient and appropriate to defend and to hold Hypertherm harmless in the event of any cause of action arising from the use of the products.

Transfer of rights

You may transfer any remaining rights you may have hereunder only in connection with the sale of all or substantially all of your assets or capital stock to a successor in interest who agrees to be bound by all of the terms and conditions of this Warranty. Within thirty (30) days before any such transfer occurs, you agree to notify in writing Hypertherm, which reserves the right of approval. Should you fail timely to notify Hypertherm and seek its approval as set forth herein, the Warranty set forth herein shall be null and void and you will have no further recourse against Hypertherm under the Warranty or otherwise.

Waterjet product warranty coverage

Product	Parts coverage
HyPrecision pumps	27 months from the ship date, or 24 months from the date of proven installation, or 4,000 hours, whichever occurs first
PowerDredge abrasive removal system	15 months from the ship date or 12 months from the date of proven installation, whichever occurs first
EcoSift abrasive recycling system	15 months from the ship date or 12 months from the date of proven installation, whichever occurs first
Abrasive metering devices	15 months from the ship date or 12 months from the date of proven installation, whichever occurs first
On/off valve air actuators	15 months from the ship date or 12 months from the date of proven installation, whichever occurs first
Diamond orifices	600 hours of use with the use of a thimble filter and compliance with Hypertherm's water quality requirements

Consumable parts are not covered by this warranty. Consumable parts include, but are not limited to, high-pressure water seals, check valves, cylinders, bleed-down valves, low-pressure seals, high-pressure tubing, low- and high-pressure water filters and abrasive collection bags. All third-party pumps, pump accessories, hoppers, hopper accessories, dryer boxes, dryer box accessories and plumbing accessories are covered by the respective manufacturers' warranties and not covered by this warranty.

Safety information

Before operating any Hypertherm equipment, read the separate *Safety and Compliance Manual (80669C) Controls and indicators* on page 39 your product for important safety information.

System description

The Powermax30 AIR is a 30 A handheld plasma cutting system that contains its own internal air compressor for maximum portability and ease of use. With it, you can cut electrically conductive metals – such as mild steel, stainless steel, or aluminum – of thicknesses up to 10 mm (3/8 inches). You can also pierce thicknesses up to 6 mm (1/4 inch).

The Powermax30 AIR ships in several different configurations, based on region. Typically all configurations include:

- 1 complete set of consumables (preinstalled on the Air T30 hand torch):
 - 1 electrode
 - 1 swirl ring
 - 1 nozzle
 - 1 retaining cap
 - 1 deflector
- 1 extra nozzle
- 1 extra electrode
- Carrying strap
- Operator Manual
- Safety and Compliance Manual
- Quick Setup Card

1 – Specifications

CSA units ship with a 120 V / 15 A (NEMA 5-15P) adapter and a 240 V / 20 A (NEMA 6-50P) adapter that connect to the NEMA twist lock-style 240 V / 20 A (NEMA L6-20P) plug wired to the power supply. CE and CCC units ship without a plug on the power cord. See *Power cord considerations* on page 27 for more information.

You can order additional consumables and accessories – such as a dust cover and circle cutting guides, for example – from any Hypertherm distributor. See *Parts* on page 63 for a list of spare and optional parts.

Power supply dimensions

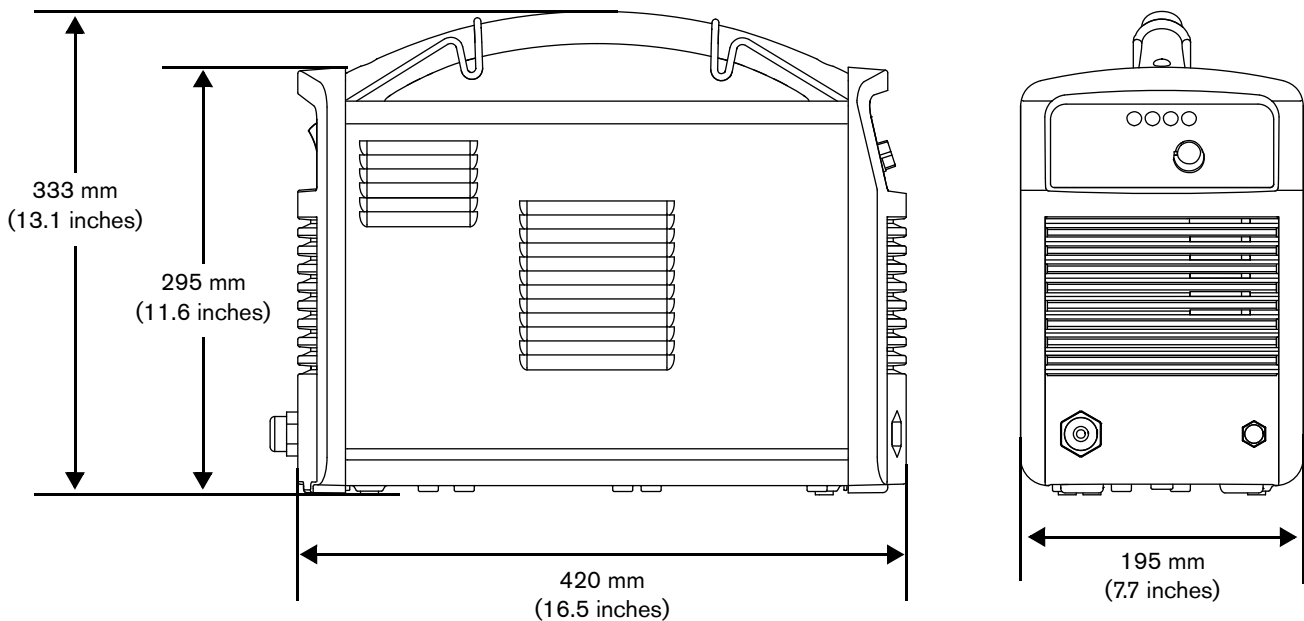

System weights

The following system weights include the hand torch with 4.6 m (15 foot) torch lead, a 4.6 m (15 foot) work lead with ground clamp, and a 3.0 m (10 foot) power cord:

- CSA systems: 13.5 kg (29.8 pounds)
- CE and CCC systems: 13.4 kg (29.5 pounds)

Hypertherm system ratings

Rated open circuit voltage (U_0)	256 VDC
Output characteristic*	Drooping
Rated output current (I_2)	15 A to 30 A
Rated output voltage (U_2) at $U_1 = 120$ VAC	83 VDC
Rated output voltage (U_2) at $U_1 = 200$ VAC – 240 VAC	83 VDC
Duty cycle at 40°C, $U_1 = 120$ VAC (See data plate on power supply's rear panel for more information on duty cycle and for IEC ratings.)	20% ($I_2 = 30$ A, $U_2 = 83$ V)
Duty cycle at 40°C, $U_1 = 200$ VAC – 240 VAC (See data plate on power supply's rear panel for more information on duty cycle and for IEC ratings.)	35% ($I_2 = 30$ A, $U_2 = 83$ V)
Operating temperature	-10°C to 40°C (14°F to 104°F)
Storage temperature	-25°C to 55°C (-13°F to 131°F)
Power factor (120 V – 240 V)	0.99 – 0.97
Idle state power consumption	14W
Power source efficiency at rated maximum output power**	86%
EMC classification CISPR 11 (CE models only)†	Class A
Input voltage (U_1)/ Input current (I_1) at rated output ($U_{2\text{ MAX}}$, $I_{2\text{ MAX}}$) (See <i>Voltage configurations</i> on page 25 for more information.)	120 V, 1-phase, 50/60 Hz, 28.7 A 200 V – 240 V, 1-phase, 50/60 Hz, 16.7 A – 15.0 A††
Gas type	Air

* Defined as a plot of output voltage versus output current.

** Power source efficiency consumption measured in a laboratory setting with internal compressor disconnected.

† WARNING: This Class A equipment is not intended for use in residential locations where the electrical power is provided by the public low-voltage supply system. There may be potential difficulties in ensuring electromagnetic compatibility in those locations, due to conducted as well as radiated disturbances.

‡ This product meets the technical requirements of IEC 61000-3-2 and IEC 61000-3-3 and is not subject to conditional connection.

Torch dimensions

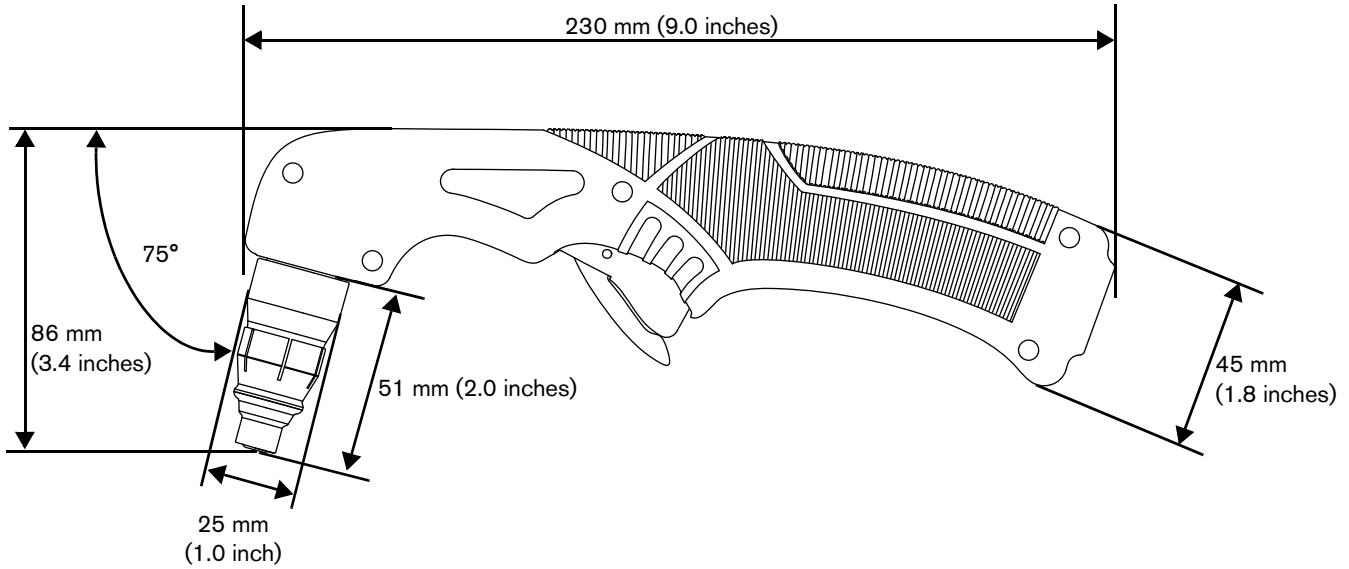

Torch weight

- Air T30 torch with consumables only: 0.3 kg (0.65 pounds)
- Air T30 torch with consumables and 4.6 m (15 foot) lead (with strain relief): 1.0 kg (2.25 pounds)

Cutting specifications

240 V	
Recommended cut capacity*	8 mm (5/16 inch) at a minimum of 500 mm/minute (20 inches/minute) 10 mm (3/8 inch) at a minimum of 250 mm/minute (10 inches/minute)
Severance cut capacity	16 mm (5/8 inch) at a minimum of 125 mm/minute (5 inches/minute)









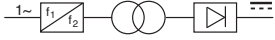

* When you operate this system at altitudes higher than 2,200 m (7,500 feet) above sea level, you may experience some reduction in cutting performance due to the adverse effect that altitude has on air compressors.

120 V
When you operate the system at the maximum recommended output of 20 A , the cut capacities are:
<ul style="list-style-type: none"> ❑ 3 mm (10 gauge) at 762 mm/minute (30 inches/minute) ❑ 6 mm (1/4 inch) at 355 mm/minute (14 inches/minute) ❑ 10 mm (3/8 inch) at 125 mm/minute (5 inches/minute)

1 – Specifications

IEC symbols

The following symbols may appear on the power supply data plate, control labels, switches, and LEDs.

	Direct current (DC)		An inverter-based power source
	Alternating current (AC)		Volt/amp curve, "drooping" characteristic
	Plasma torch cutting		Power is ON (LED)
	AC input power connection		Internal air compressor fault (LED)
	The terminal for the external protective (earth) conductor		Missing or loose consumables (LED)
I	Power is ON		Power supply is overheated (LED)
O	Power is OFF		

Noise levels

This plasma system can make more than the permitted acoustical noise levels as defined by national and local codes. Always put on correct ear protection when cutting or gouging. Any acoustical noise measurements taken are related to the specific environment in which the system is used. Refer to *Noise can damage hearing* in the *Safety and Compliance Manual* (80669C).

In addition, you can find an *Acoustical Noise Data Sheet* for your system at www.hypertherm.com/docs. In the search box, enter **data sheet**.

Symbols and marks

Your product may have one or more of the following marks on or near the data plate. Because of differences and conflicts in national regulations, not all marks are applied to every version of a product.



S mark

The S mark indicates that the power supply and torch are suitable for operations carried out in environments with increased hazard of electrical shock according to IEC 60974-1.



CSA mark

Products with a CSA mark meet the United States and Canadian regulations for product safety. The products were evaluated, tested, and certified by CSA-International. Alternatively, the product may have a mark by one of the other Nationally Recognized Testing Laboratories (NRTL) accredited in both the United States and Canada, such as UL or TÜV.



CE mark

The CE marking signifies the manufacturer's declaration of conformity to applicable European directives and standards. Only those versions of products with a CE marking located on or near the data plate comply with European Directives. Applicable directives may include the European Low Voltage Directive, the European Electromagnetic Compatibility (EMC) Directive, the Radio Equipment Directive (RED), and the Restriction of Hazardous Substances (RoHS) Directive. See the European CE Declaration of Conformity for details.



Eurasian Customs Union (CU) mark

CE versions of products that include an EAC mark of conformity meet the product safety and EMC requirements for export to Russia, Belarus, and Kazakhstan.



GOST-TR mark

CE versions of products that include a GOST-TR mark of conformity meet the product safety and EMC requirements for export to the Russian Federation.



RCM mark

CE versions of products with an RCM mark comply with the EMC and safety regulations required for sale in Australia and New Zealand.



CCC mark

The China Compulsory Certification (CCC) mark indicates that the product has been tested and found compliant with product safety regulations required for sale in China.



UkrSEPRO mark

The CE versions of products that include a UkrSEPRO mark of conformity meet the product safety and EMC requirements for export to the Ukraine.



Serbian AAA mark

CE versions of products that include a AAA Serbian mark meet the product safety and EMC requirements for export to Serbia.



RoHS mark

The RoHS mark indicates that the product meets the requirements of the European Restriction of Hazardous Substances (RoHS) Directive.



United Kingdom Conformity Assessed mark

CE versions of products that include a UKCA mark of conformity meet the product safety, EMC, RF, and RoHS requirements for export to the UK.

Section 2

Power Supply Setup

Unpack the plasma system

1. Make sure that you received all items on your order in good condition. Contact your distributor if any parts are damaged or missing. (See *System contents* on page 24.)
2. Inspect the system for damage that may have occurred during shipment. If you find evidence of damage, see *Claims*, below. All communications regarding this equipment must include the model number and the serial number located on the rear panel of the power supply.
3. Before you set up and operate this system, read the separate *Safety and Compliance Manual* (80669C) included with your system for important safety information.

Claims

- **Claims for damage during shipment** – If your unit was damaged during shipment, file a claim with the carrier. You can contact Hypertherm for a copy of the bill of lading. If you need additional assistance, call the nearest Hypertherm office listed in the front of this manual.
- **Claims for defective or missing merchandise** – If any component is missing or defective, contact your Hypertherm distributor. If you need additional assistance, call the nearest Hypertherm office listed in the front of this manual.

System contents

The following illustration shows the components typically included with all system configurations.

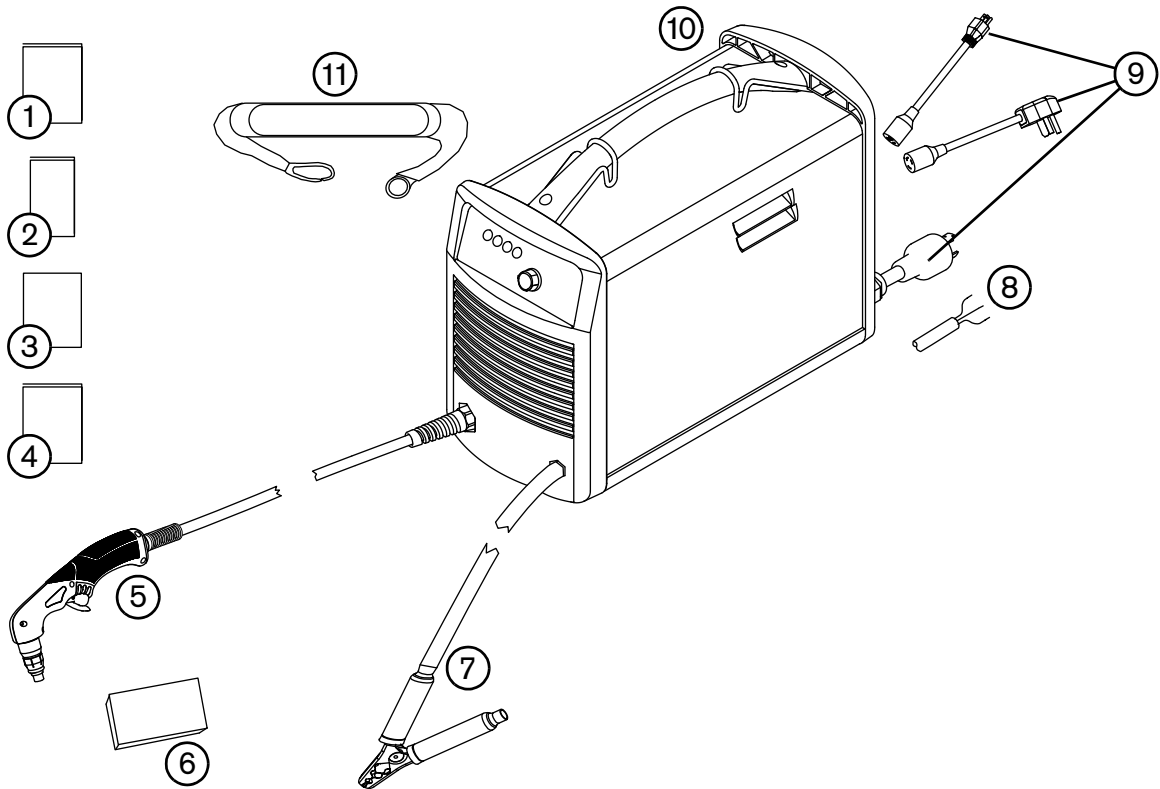



- | | | | |
|---|------------------------------|----|--|
| 1 | Operator Manual | 7 | Ground clamp and work lead |
| 2 | Quick Setup Card | 8 | CE/CCC power cord (no power plug included) |
| 3 | Registration card | 9 | CSA power cord with power plug adapters |
| 4 | Safety and Compliance Manual | 10 | Power supply |
| 5 | Air T30 torch with lead | 11 | Carrying strap |
| 6 | Consumable kit | | |



The specific components included with the system are subject to change over time.

Position the plasma cutting system

- Position the plasma system near an appropriate power receptacle. The system has a 3.0 m (10 foot) power cord.
- Allow at least 0.25 m (10 inches) of space around the power supply for proper ventilation.
- When positioning the plasma system, be aware that excess moisture from the internal compressor exits through a hole in the base, underneath the power supply. You may see a small puddle form under the power supply as you operate the system.
- Place the power supply on a stable, level surface before using. The power supply can tip over if set at an angle greater than 10 degrees.
- Do not place the power supply on its side. Doing so can prevent proper air circulation needed to cool internal components. It can also divert air away from the torch and prevent it from working properly.
- Be aware that when you operate this system at altitudes higher than 2,200 m (7,500 feet) above sea level, you may experience some reduction in cutting performance due to the adverse effect that altitude has on air compressors.
- Do not use the system in rain or snow.

		<p style="text-align: center;">WARNING! CHANCE OF ELECTRIC SHOCK</p>
<p style="text-align: center;">Never cut under water or submerge the torch in water. Electric shock can cause serious injury.</p>		

Prepare the electrical power

The system's maximum output voltage varies based on the input voltage and the circuit's amperage.

Additional factors must be considered when you are operating the system at an input power of 120 V, as tripped circuit breakers can result under some conditions. For more information, see *System operation guidelines* on page 47 and *Basic troubleshooting* on page 56.

Voltage configurations

The system automatically adjusts for proper operation at the current input voltage without requiring you to perform any switching or rewiring. However, you must make sure that an appropriate set of consumables is properly installed in the torch and the amperage adjustment knob is set to an appropriate output current. For more information, see *Step 1 – Install the consumables* on page 41 and *Step 3 – Adjust the output current* on page 43.

The following tables show the maximum rated output for typical combinations of input voltage and amperage. The output setting you need to use depends on the thickness of the metal and is limited by the input power to your system.

 Hypertherm does not recommend operating this system on a 120 V / 15 A circuit.

The Hypertherm rated output is:

- 15 A – 30 A maximum output current
- 83 VDC maximum rated output voltage
- 2.5 kW cutting power

2 – Power Supply Setup

Determine the plasma system's cutting power in watts by multiplying its maximum output amperage by its maximum rated output voltage:

$$30 \text{ A} \times 83 \text{ VDC} = 2,490 \text{ W (or 2.5 kW).}$$

	CAUTION!
A circuit capable of 120 V / 20 A or 240 V / 20 A is required for proper operation. Protect the circuit with appropriately sized slow-blow (time-delay) fuses or circuit breakers.	

Table 1 – 120 V / 20 A

Input voltage	120 V
Input current at rated output (19 A × 83 V = 1.6 kW)	19.2 A
Input current at arc stretch	37.5 A
Voltage tolerance	+20% / -15%

Table 2 – 120 V / 30 A

Input voltage	120 V
Input current at rated output (30 A × 83 V = 2.5 kW)	28.7 A
Input current at arc stretch	37.5 A
Voltage tolerance	+20% / -15%

Table 3 – 200 V – 240 V / 16 A

Input voltage	200 V – 240 V
Input current at rated output (28 A × 83 V = 2.3 kW)	15.8 A – 13.4 A
Input current at arc stretch	37.5 A
Voltage tolerance	+20% / -15%

Table 4 – 200 V – 240 V / 20 A

Input voltage	200 V – 240 V
Input current at rated output (30 A × 83 V = 2.5 kW)	16.7 A – 15.0 A
Input current at arc stretch	37.5 A
Voltage tolerance	+20% / -15%

Requirements for grounding

Properly ground the system as follows to ensure personal safety and proper operation, and to reduce electromagnetic interference (EMI):

- The system must be grounded through the power cord according to national and local electrical codes.
- Single-phase service must be of the three-wire type with a green (CSA) or green/yellow (CE/CCC) wire for the protective earth ground and must comply with national and local requirements. **Do not use a two-wire service.**
- Refer to the *Safety and Compliance Manual (80669C)* for more information.

Power cord considerations

This system ships with a CSA or CE, or CCC power cord configuration.

CSA power cords and plugs

CSA configurations include the following plug and adapters.

- The power cord is equipped with a NEMA twist lock-style plug (NEMA L6-20P) appropriate for use on a 240 V / 20 A circuit with a NEMA twist lock-style outlet.

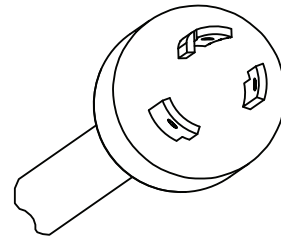

- To operate the system on a lower amperage circuit, attach the female end of the 120 V / 15 A (NEMA 5-15P) plug adapter to the power supply's NEMA twist lock-style plug.

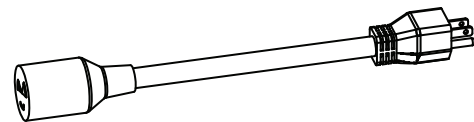

 Do not set the amperage adjustment knob above 20 A, or you may trip the circuit breaker. See *Step 3 – Adjust the output current* on page 43.

- To operate the system on a 240 V / 20 A circuit, attach the female end of the 240 V / 20 A (NEMA 6-50P) plug to the power supply's NEMA twist lock-style plug.

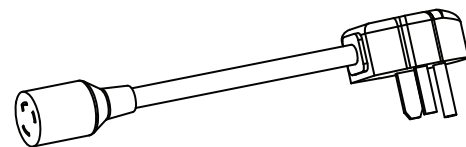

2 – Power Supply Setup

CE and CCC power cords

CE and CCC configurations ship without a plug on the power cord. To operate at 220 V (CCC) or 230 V (CE), obtain the correct plug for your unit and location and have it installed by a licensed electrician.

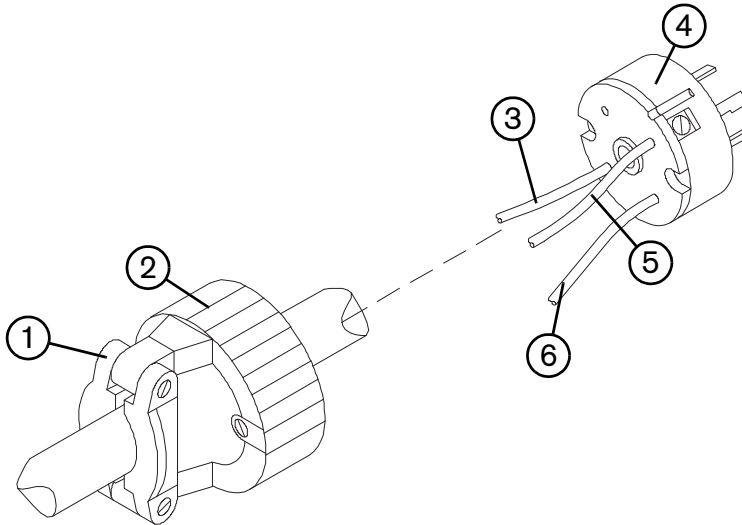

- | | | | |
|---|----------------------------|---|-----------------------------------|
| 1 | Cord grip | 4 | 220 V (CCC) or 230 V (CE) plug |
| 2 | Outer shell | 5 | To line 2 terminal (blue) |
| 3 | To line 1 terminal (brown) | 6 | To ground terminal (green/yellow) |

Install a plug on the power cord

1. Strip back the cord insulation to separate wires 3, 5, and 6.
2. Remove each wire's insulation to allow good contact with the plug terminals.
3. Make the connections.
4. Reinstall the outer shell and cord grip, and tighten the cord grip's screws until snug. Do not overtighten.

Extension cord recommendations

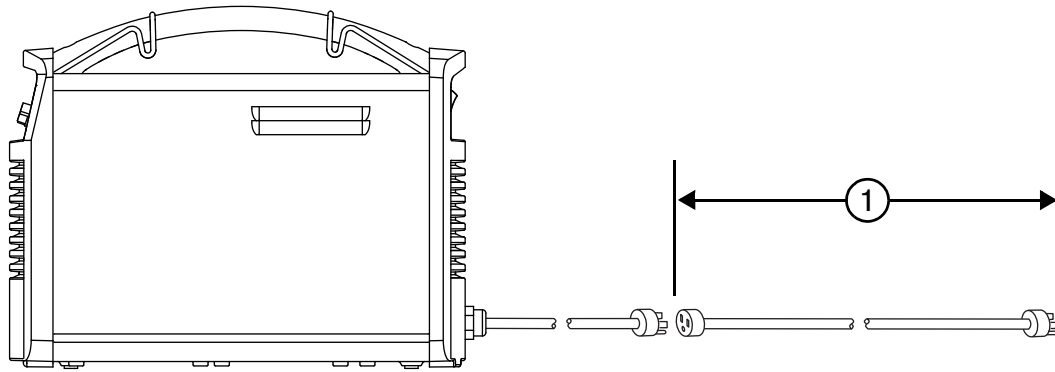

Use an extension cord of an appropriate wire gauge for the cord length and system voltage. Use a cord that meets national and local codes.

Input voltage	Phase	①	
		Recommended cord gauge size	Length
120 VAC	1	4 mm ² (12 AWG)	Up to 16 m (53 feet)
240 VAC	1	2 mm ² (14 AWG)	Up to 40.5 m (133 feet)

 Extension cords can cause the machine to receive less input voltage than the output of the circuit. This can limit the operation of your system.

Generator recommendations

Generators used with this system should produce 240 VAC.

Engine drive rating	Engine drive output current 1-phase (CSA/CE/CCC)	Performance (arc stretch)
5.5 kW	30 A	Full
4 kW	25 A	Limited

 Adjust the cutting current as needed based on the generator rating, age, and condition.

 If a fault occurs while using a generator, turn OFF the system and wait approximately 60 seconds before turning it ON again. Turning the power switch quickly to OFF and ON again (called a “quick reset”) may not clear the fault.

Introduction

The Powermax30 AIR includes the Air T30 hand torch. This section explains how to set up and operate your torch. To achieve optimal consumable life and cut quality, follow the instructions in this manual.

Hand torch components

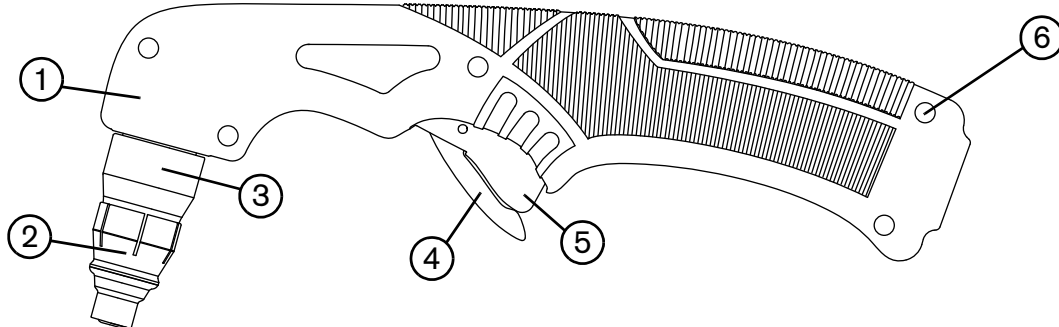

- | | |
|-----------------|-----------------|
| 1 Handle | 4 Safety catch |
| 2 Deflector | 5 Trigger (red) |
| 3 Retaining cap | 6 Screws (5) |

Consumable life

Consumable life varies based on the following factors:

- Thickness of the metal.
- Length of the average cut.
- Type of cutting (piercing decreases life when compared to edge cutting).
- Pierce height (stretching the arc).
- Whether you are cutting solid metal or expanded metal. Cutting expanded metal wears out consumables more quickly. For more information, see *Cutting expanded metal* on page 43.



Hypertherm does not recommend the use of any other consumables in the Air T30 torch except for those listed in this section, which are designed specifically for this system. The use of any other consumables could adversely affect system performance.

Although largely dependent on the factors listed above, as a general rule, the consumables last approximately 1 to 2 hours of actual “arc on” time. See *Inspect the consumables* on page 55 for information on the signs of wear to look for in consumables.



If the consumables’ life is shorter than expected or the cut quality is poor, make sure that you are using the correct consumables and that they are properly installed. (See the following topic, *Consumable use*.) Under normal conditions, the nozzle wears out first.



For optimal cutting performance, always replace the nozzle and the electrode together.

See *Hand torch operation* on page 48 for more information about proper cutting techniques.

Consumable use

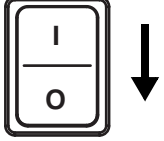
		<p>WARNING!</p> <p>INSTANT-ON TORCHES</p> <p>PLASMA ARC CAN CAUSE INJURY AND BURNS</p>
	<p>The plasma arc ignites immediately when you pull the torch trigger. Make sure the power is OFF before changing consumables.</p>	

The hand torch ships with a complete set of consumables installed. The consumables are designed for a broad range of cutting applications.

The amperage output setting you need to use depends on the thickness of the metal you are planning to cut and is limited by the input power to your system. See *Voltage configurations* on page 25.

-  Do not use any other consumables in the Air T30 torch except for those listed in this section, which are designed specifically for this system. The use of any other consumables could adversely affect system performance.

Using the cut charts

Use the following cut charts to guide you in selecting the cutting current (amperage) based on the thickness and type of the metal you need to cut.

The maximum cut speeds listed in the cut charts are the fastest possible speeds to cut metal without regard to cut quality. Adjust the cutting speed for your application to obtain the desired cut quality.

3 – Torch Setup

Consumable set

A complete set of consumables includes:

- Electrode
- Swirl ring
- Nozzle
- Retaining cap
- Deflector



Hypertherm does not recommend operating this system on a 120 V / 15 A circuit.

The following consumables are designed specifically for use with the Powermax30 AIR power supply and Air T30 hand torch. They cannot be used with any other Powermax system or torch.

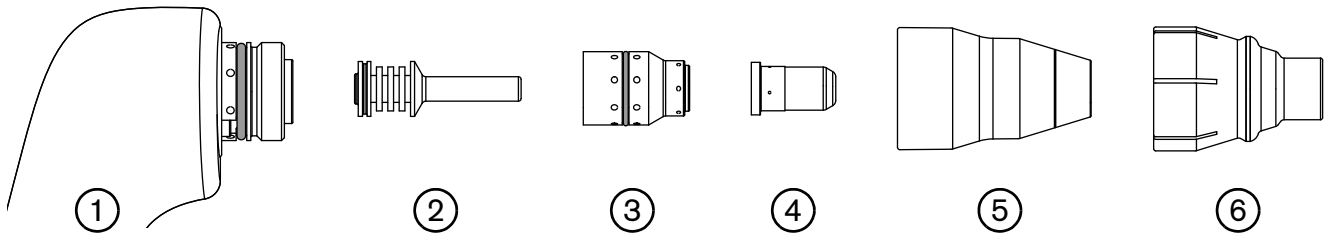

- 1 Torch
- 2 Electrode
- 3 Swirl ring

- 4 Nozzle
- 5 Retaining cap
- 6 Deflector

240 V / 30 A cutting

Metric

Material thickness (mm)	Material	Arc current (A)	Maximum cut speed (mm/minute)
1	Mild steel	30	10,160 [†]
2			5,145
3			2,545
4			1,450
5			1,155
7*			570
9*			400
11*			280
13*			215
16*			125
1	Stainless steel	30	10,160 [†]
2			3,290
3			1,970
4			1,260
5			980
7*			535
9*			310
11*			215
13*			170
1			Aluminum
2	6,630		
3	3,585		
4	2,370		
5	1,770		
7*	575		
9*	435		
11*	245		
13*	135		

* To cut material thicker than 6 mm (1/4 inch) at 240 V, start the torch at the edge of the workpiece.

† Maximum cut speed is limited by the test table's maximum speed (10,160 mm/minute or 400 inches/minute).

3 – Torch Setup

English

Material thickness (gauge/inches)	Material	Arc current (A)	Maximum cut speed (inches/minute)
18 gauge	Mild steel	30	395
14 gauge			214
12 gauge			130
10 gauge			64
1/4			30
5/16*			22
3/8*			13
1/2*			9
5/8*			5
18 gauge			Stainless steel
14 gauge	135		
10 gauge	56		
1/4	24		
3/8*	10		
1/2*	7		
1/32	Aluminum	30	400†
1/16			306
1/8			111
1/4			38
3/8*			13
1/2*			6

* To cut material thicker than 6 mm (1/4 inch) at 240 V, start the torch at the edge of the workpiece.

† Maximum cut speed is limited by the test table's maximum speed (10,160 mm/minute or 400 inches/minute).

120 V / 20 A cutting

Metric

Material thickness (mm)	Material	Arc current (A)	Maximum cut speed (mm/minute)
1	Mild steel	20	6,540
2			2,420
3			1,245
4*			680
6*			400
8*			235
10*			90
1	Stainless steel	20	3,295
2			2,140
3			1,270
4*			965
5*			660
7*			150
1	Aluminum	20	5,500
2			3,610
3			1,720
4*			1,030
5*			740
7*			165

* To cut material thicker than 3 mm (10 gauge) at 120 V, start the torch at the edge of the workpiece.

3 – Torch Setup

English

Material thickness (gauge/inches)	Material	Arc current (A)	Maximum cut speed (inches/minute)
18 gauge	Mild steel	20	220
14 gauge			100
10 gauge			30
1/4*			14
3/8*			5
18 gauge	Stainless steel	20	120
14 gauge			89
12 gauge			54
1/4*			10
1/32	Aluminum	20	231
1/16			170
1/8			49
1/4*			14

* To cut material thicker than 3 mm (10 gauge) at 120 V, start the torch at the edge of the workpiece.

Controls and indicators

Familiarize yourself with the controls and LED indicators on the system before you begin cutting.

Rear controls

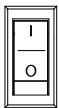
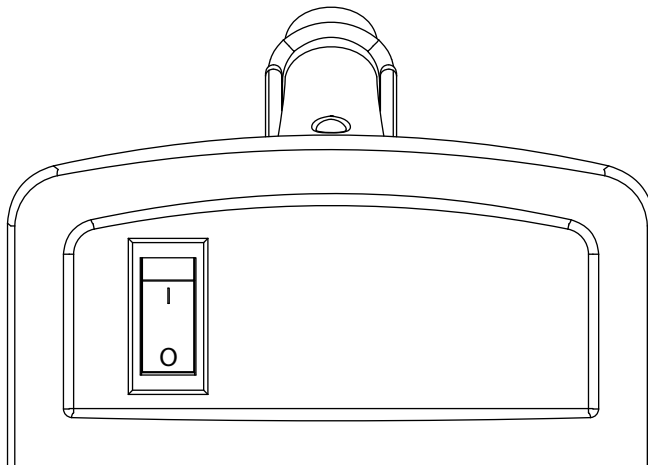

ON (I) / OFF (O) power switch
Activates the system and its control circuits.

Front panel controls and indicator LED symbols

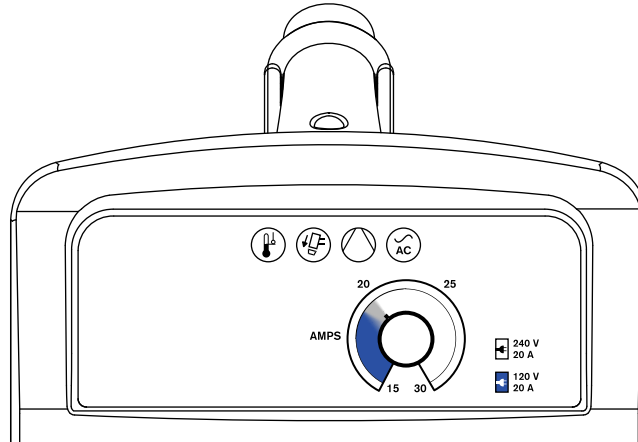

Power ON LED (green) – When illuminated, this LED indicates that the power switch has been set to ON (I) and that the safety interlocks are satisfied.



Internal compressor LED (yellow) – When illuminated, this LED indicates a possible issue with the internal air compressor.



Torch cap LED (yellow) – When illuminated, this LED indicates that the consumables are loose, improperly installed, or missing.



Temperature LED (yellow) – When illuminated, this LED indicates that the system's temperature is outside the acceptable operating range.



Some fault conditions cause multiple LEDs to illuminate or blink at the same time. For information on what these fault conditions are and how to clear them, see *Basic troubleshooting* on page 56.

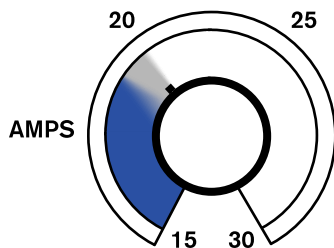

 240 V
20 A

 120 V
20 A

Amperage adjustment knob – Use this knob to set the output current between 15 A and 30 A.

Operate the plasma system

The following topics explain how to begin cutting with the plasma system.

Step 1 – Install the consumables

		WARNING! INSTANT-ON TORCHES PLASMA ARC CAN CAUSE INJURY AND BURNS
		<p>The plasma arc ignites immediately when you pull the torch trigger. Make sure the power is OFF (O) before changing consumables.</p>

Before operating the plasma system and hand torch, first make sure:

1. The power switch on the power supply is in the OFF (O) position.
2. A complete set of consumables is installed on the hand torch as shown:

- ① Electrode
- ② Swirl ring
- ③ Nozzle
- ④ Retaining cap
- ⑤ Deflector*

* Install the deflector by snapping it securely into place on the retaining cap.

 **Do not apply grease or other lubricants to the O-rings on the electrode and swirl ring.**

 These consumables are designed specifically for the Powermax30 AIR power supply and Air T30 hand torch. They cannot be used with any other Powermax system or torch.

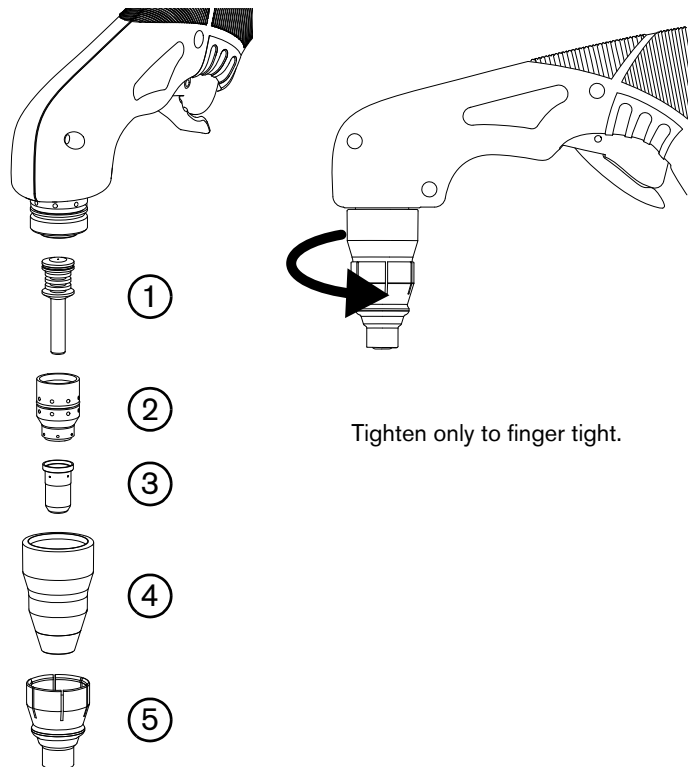

Tighten only to finger tight.

4 – Operation

Step 2 – Connect the electrical power

Plug in the power cord.

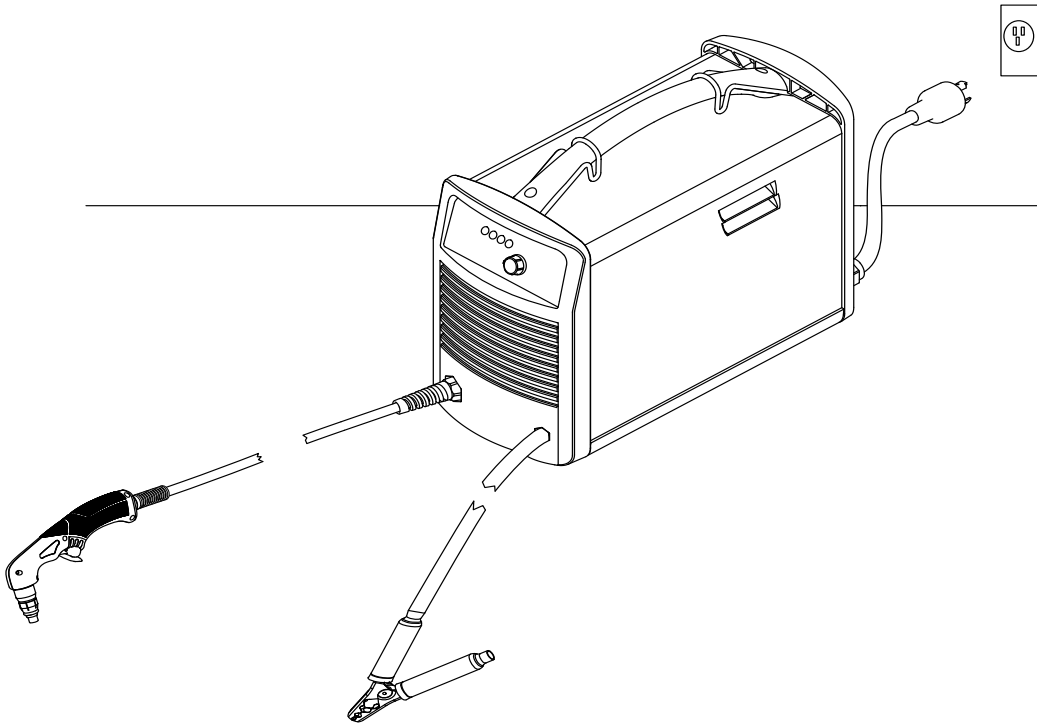

See also

- For information on connecting the proper plug to the power cord, see *Power cord considerations* on page 27.
- To understand what cutting capacity to expect based on input voltage, see *Consumable use* on page 33.
- For information on electrical requirements for this system, see *Power Supply Setup* on page 23.

Step 3 – Adjust the output current

The power ON LED illuminates when the system is powered ON and ready to operate.

If any of the other LEDs illuminate or blink, do not try to cut – a fault has occurred. Refer to *Basic troubleshooting* on page 56 for a list of troubleshooting steps to follow.

When the system is ready to cut, turn the amperage knob to the desired output current based on the input voltage and circuit size.

Operating the system on a 120 V / 20 A circuit

- Set the amperage below 20 A, as indicated by the blue shading around the knob (the thick inner ring).
- Make sure nothing else is drawing power from the circuit.

 Hypertherm does not recommend operating this system on a 120 V / 15 A circuit.

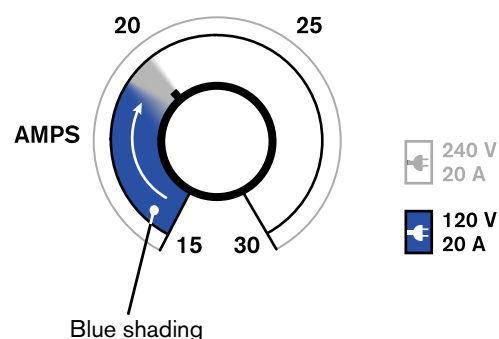

Operating the system on a 240 V / 20 A circuit

- Set the amperage between 15 – 30 A.

Decrease output current for lower-rated power plugs

If you are operating the system using a lower-rated power plug or service, turn down the output current to avoid tripping the circuit breaker.

For example, to operate the system on a 230 V / 16 A circuit, set the amperage below 28 A.

 See *Voltage configurations* on page 25 for more information.

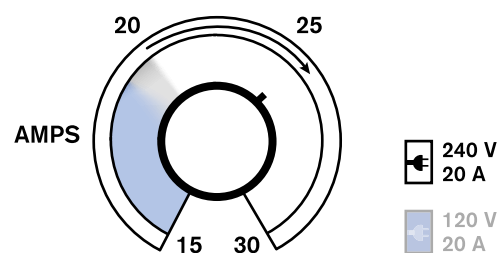

Cutting expanded metal

Use the consumables that come with the torch to cut expanded metal. (Expanded metal has a slotted or mesh pattern.) The system does not require a dedicated mode for cutting expanded metal.

Cutting expanded metal wears out consumables more quickly because it requires a continuous pilot arc. A pilot arc occurs when the torch is fired but the plasma arc is not in contact with the workpiece.

For best results, operate on a higher rated circuit (240 V / 20 A).

Step 4 – Attach the ground clamp

Attach the ground clamp to the workpiece.

- Make sure the ground clamp and the workpiece make good metal-to-metal contact.
- Attach the ground clamp as close as possible to the area being cut to reduce exposure to electric and magnetic fields (EMF) and to achieve the best possible cut quality.
- **Do not attach the ground clamp to the portion of the workpiece that you are cutting away.**

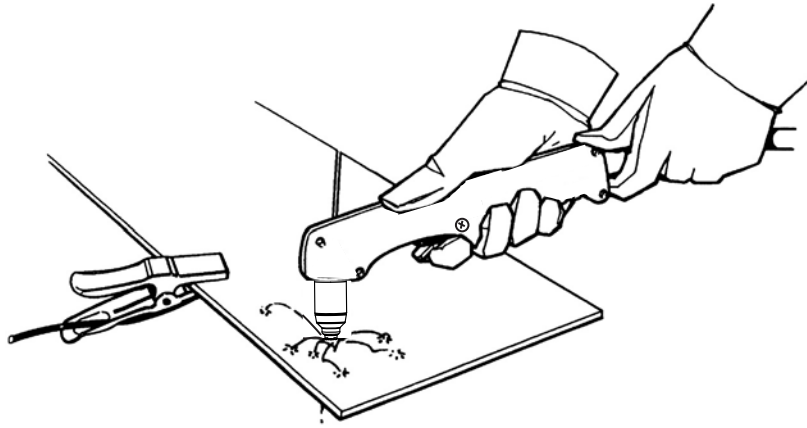

Step 5 – Power ON the system

Set the ON/OFF switch to the ON (I) position.

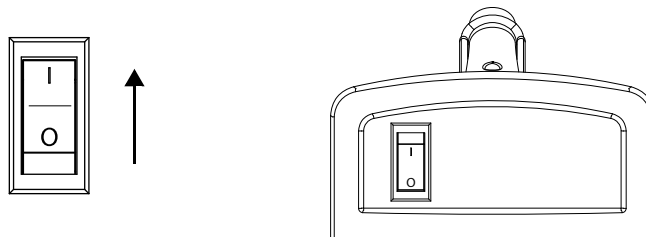

Step 6 – Check the indicator LEDs

Make sure the green power ON LED on the front of the power supply is illuminated and that none of the other LEDs are illuminated or blinking.

If the temperature, torch cap sensor, or internal compressor LEDs illuminate or blink, or if the power ON LED blinks, this indicates a fault. Correct the fault condition before continuing. See *Basic troubleshooting* on page 56 for more information.

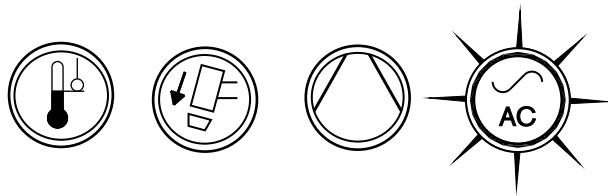

Step 7 – Make sure the system is ready, and start cutting

When the power ON LED illuminates, none of the other LEDs illuminate or blink, and the amperage knob is set, the system is ready for use.

What to expect during and after cutting

Water at the torch nozzle

- A small amount of moisture at the torch nozzle is normal for this system, particularly in very humid environments. It should not prevent the torch from firing or degrade cut quality or performance.

Postflow

- After you complete a cut and release the torch trigger, air continues to flow from the torch in order to cool the consumables. This is referred to as *postflow*.
- The length of postflow depends on how long the torch fired a sustained arc:

Length of time arc was sustained	Length of postflow
0 – 5 seconds	5 seconds
> 5 – 21 seconds	10 seconds
> 21 – 135 seconds	15 seconds
> 135 seconds	20 seconds

Internal compressor and fan activity

- The internal compressor runs while you are cutting, and it continues to run during postflow.
- The fan inside the power supply runs for 7 minutes after postflow. It also runs intermittently during cutting.

Water under the power supply

- When cutting, you may see a small puddle form underneath the power supply because the system automatically purges excess moisture from the internal compressor. It expels this water through a hole in the bottom of the power supply.

Understand duty-cycle limitations

The duty cycle is the percentage of time out of 10 minutes that a plasma arc can remain on when operating at an ambient temperature of 40°C (104°F).

- **35% duty cycle at 240 V / 30 A:** With input power of 240 V and the output current set to 30 A, the arc can remain on for 3.5 minutes out of 10 minutes without causing the unit to overheat.
- **20% duty cycle at 120 V / 30 A*:** With input power of 120 V and the output current set to 30 A, the arc can remain on for 2.0 minutes out of 10 minutes without causing the unit to overheat.

* Although the duty cycle is rated for 30 A output, the recommended output current for 120 V circuits is 20 A or less. Operating the system at 30 A on 120 V input can result in frequent tripped circuit breakers.

When you exceed the duty cycle and the system overheats, one of the following conditions occurs:

- The temperature LED illuminates, the arc shuts off, and the cooling fan continues to run. To resume cutting, wait for the temperature LED to extinguish.
- The internal compressor LED and the temperature LED both illuminate. Allow the power supply to cool for 4 minutes before using it again. If the problem persists, see *Internal compressor LED faults* on page 58 for more troubleshooting tips.





When either condition occurs, leave the system on to allow the fan to cool the power supply. The fan runs for 7 minutes after postflow.

Stretching the arc for prolonged periods while cutting can reduce the duty cycle. Stretching the arc requires the power supply to generate a higher voltage output, which can cause it to run hotter and overheat more quickly.

System operation guidelines

- To achieve the highest level of performance:
 - Operate the system at an input power of 240 VAC whenever possible.
 - Do not operate the system on a 120 V / 15 A circuit.
 - Avoid using an extension cord whenever possible.
-  If you must use an extension cord, use a heavy conductor cord of the shortest possible length. See *Extension cord recommendations* on page 29.
- If you are operating your system on a 120 V / 20 A circuit, do not set the amperage higher than 20 A. See *Voltage configurations* on page 25.
- For best results when operating your system on a 120 V / 20 A circuit:
 - Do not connect anything else that will draw power from the same circuit.
 - Be aware that extension cords can reduce the voltage to the machine from what is output by the circuit. This reduction in power can impair cutting performance and increase the probability of tripping the circuit breaker.
- Cutting a thicker workpiece requires a higher amperage setting. It is preferable to operate on a higher rated circuit (240 V / 30 A) when cutting thicker metal. See *Voltage configurations* on page 25.
- Additional techniques to reduce the frequency of tripped circuit breakers include:
 - Turn down the amperage adjustment knob.
 - Avoid stretching the arc. Instead, drag the torch on the workpiece as explained in *Edge start on a workpiece* on page 50.
- When you operate the system at altitudes higher than 2,200 m (7,500 feet) above sea level, you may experience some reduction in cutting performance due to the adverse effect that altitude has on the internal air compressor.

Hand torch operation

		<p style="text-align: center;">WARNING! INSTANT-ON TORCHES PLASMA ARC CAN CAUSE INJURY AND BURNS</p>
<p>Plasma arc ignites immediately when you pull the torch trigger. The plasma arc cuts quickly through gloves and skin.</p> <p>Keep hands, clothes, and objects away from the torch tip.</p> <p>Do not hold the workpiece, and keep your hands clear of the cutting path.</p> <p>Never point the torch toward yourself or others.</p>		

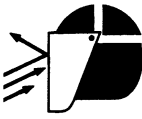
		<p style="text-align: center;">WARNING! SPARKS AND HOT METAL CAN INJURE EYES AND BURN SKIN</p>
<p>Always wear proper protective equipment including gloves and eye protection, and point the torch away from yourself and others. Sparks and hot molten metal spray out from the nozzle.</p>		

Safety catch operation

The torch is equipped with a safety catch to prevent accidental firings. When you are ready to cut with the torch, flip the safety catch forward (toward the torch head) and pull the red torch trigger.

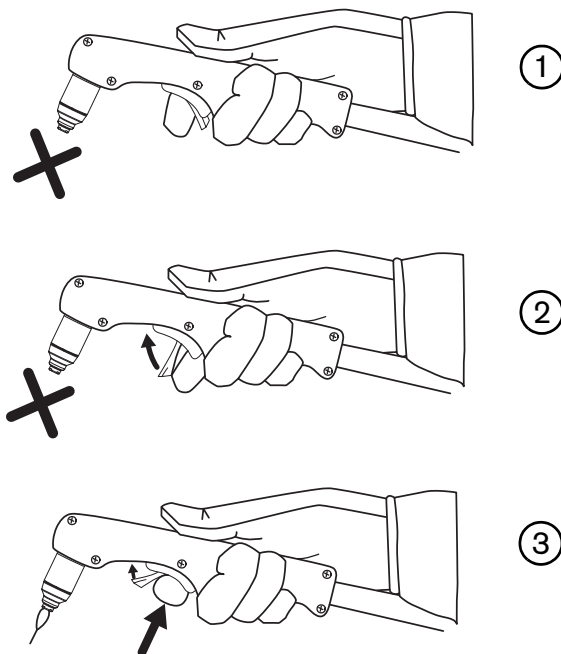

Hand torch cutting guidelines

- Drag the torch tip lightly on the workpiece to maintain a steady cut speed.



With drag-cutting, it is normal to experience the torch sticking slightly to the workpiece.

- While cutting, make sure that sparks exit from the bottom of the workpiece. The sparks should lag slightly behind the torch as you cut ($15^\circ - 30^\circ$ angle from vertical).
- If sparks spray up, you are not cutting all the way through the workpiece. Move the torch more slowly, or, if possible, increase the output current.
- Hold the torch nozzle perpendicular to the workpiece so that the nozzle is at a 90° angle to the cutting surface, and watch the arc as it cuts along the line.

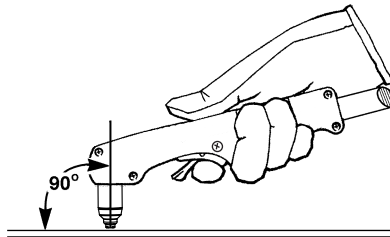

- Pulling the torch toward you along the cut is easier than pushing it or moving from side-to-side.
- For straight-line cuts, use a straight edge as a guide. To cut circles, use a template or a radius cutter attachment (a circle cutting guide). See *Accessory parts* on page 67 for the Hypertherm plasma cutting guide part numbers for cutting circles and making bevel cuts.
- If you fire the torch unnecessarily, you shorten the life of the nozzle and electrode.



Recommendations for cutting at 120 V

- Do not operate the system on a 15 A circuit.
- Do not use an extension cord.
- Make sure nothing else is drawing power from the circuit.
- Turn down the current adjustment knob to avoid tripping the breaker.

Edge start on a workpiece

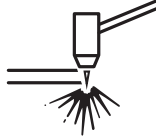

When cutting material up to 10 mm (3/8 inch) thick, start the torch at the edge of the workpiece to prolong consumable life.

1. With the ground clamp attached to the workpiece, hold the torch perpendicular (90°) to the workpiece and on the edge.

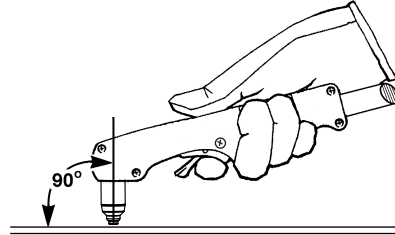

2. Pull the torch trigger to start the arc. You may need to pause at the edge until the arc has cut completely through the workpiece.

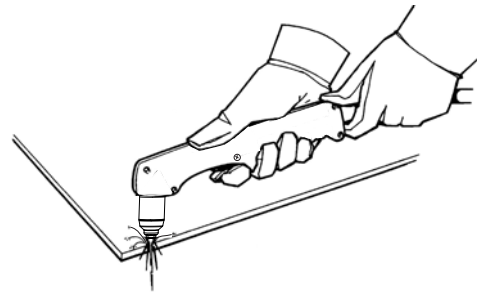

3. Drag the torch lightly across the workpiece to proceed with the cut. Maintain a steady, even pace.

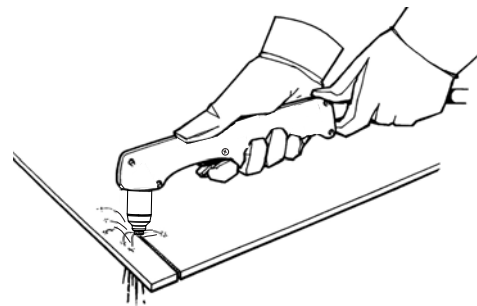

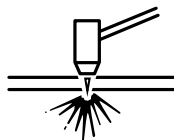
Pierce a workpiece

When cutting material up to 6 mm (1/4 inch) thick, use piercing to cut an interior feature. Piercing shortens the life of the deflector and the nozzle.

The type of pierce to perform depends on the thickness of the metal:

- ❑ **Straight pierce** – For cutting mild or stainless steel that is thinner than 3 mm (10 gauge).
- ❑ **Rolling pierce** – For cutting mild or stainless steel that is 3 mm (10 gauge) or thicker.

1. Attach the ground clamp to the workpiece.

2. **Straight pierce:** Hold the torch perpendicular (90°) to the workpiece with the torch tip just above the workpiece.

Rolling pierce: Hold the torch at an approximate 30° – 45° angle to the workpiece with the torch tip within 1.5 mm (1/16 inch) of it before firing the torch.

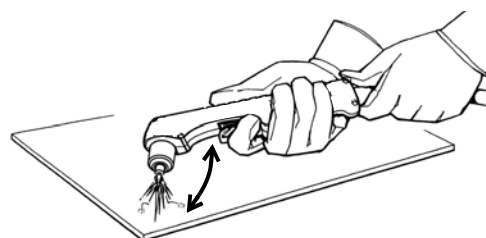

30° – 45° for rolling pierce

3. **Straight pierce:** Pull the torch trigger to start the arc.

Rolling pierce: Pull the torch trigger to start the arc while still at an angle to the workpiece, then rotate the torch to the perpendicular (90°) position.

4. Hold the torch in place while continuing to pull the trigger. When sparks exit from the bottom of the workpiece, the arc has pierced the metal.

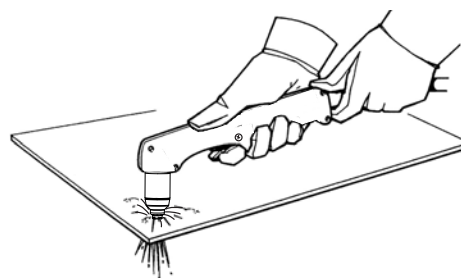

5. When the pierce is complete, drag the torch lightly along the workpiece to proceed with the cut.

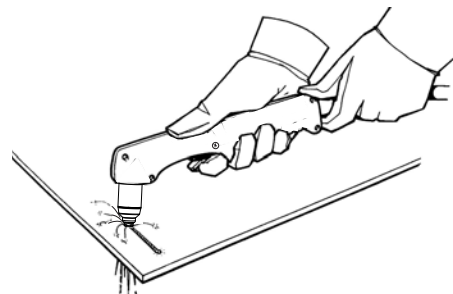

Common hand-cutting faults

For more information on faults, see *Basic troubleshooting* on page 56.

- The torch sputters and hisses, but does not produce an arc. The cause can be:
 - Overtightened consumables
- The torch does not cut completely through the workpiece. The causes can be:
 - Cut speed is too fast
 - Worn consumables
 - Metal being cut is too thick for the selected amperage
 - Installation of the wrong consumables
 - Poor electrical contact between the ground clamp and the workpiece
- Cut quality is poor. The causes can be:
 - Metal being cut is too thick for the selected amperage
 - Installation of the wrong consumables
 - Cut speed is too fast or too slow
 - Worn or damaged consumables
- The arc sputters and consumables life is shorter than expected. The causes can be:
 - Incorrect installation of the consumables
 - Installation of the wrong consumables
 - Moisture in the consumables or in the air supply within the system

Minimizing dross

Dross is the molten metal that solidifies on the workpiece. Some amount of dross is always present when cutting with air plasma. However, you can control the amount and type of dross by adjusting your system correctly for your application.

Low-speed dross forms when the torch's cutting speed is too slow and the arc shoots ahead. It forms as a heavy, bubbly deposit at the bottom of the cut and is usually easy to remove. Increase your speed to reduce this type of dross.

High-speed dross forms when the cutting speed is too fast and the arc lags behind. It forms as a thin, linear bead of solid metal attached very close to the cut. It forms to the bottom of the cut and is often more difficult to remove. Decrease your speed to reduce this type of dross.





Dross is more likely to form on warm or hot metal than on cool metal. For example, the first cut in a series of cuts is likely to produce the least dross. As the workpiece heats up, more dross may form on subsequent cuts.



Worn or damaged consumables may produce intermittent dross.

Perform routine maintenance

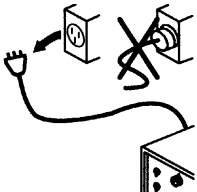
		<p>WARNING! ELECTRIC SHOCK CAN KILL</p>
		<p>Disconnect electrical power before performing any maintenance that involves removing the cover from the power supply or the consumables from the torch.</p> <p>All work requiring removal of the power supply cover must be performed by a qualified technician.</p> <p>See the <i>Safety and Compliance Manual (80669C)</i> for more safety precautions.</p>

Every use:

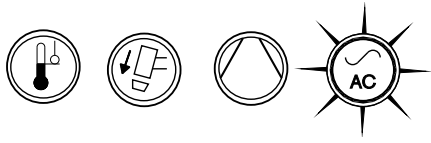

Check the indicator lights and correct any fault conditions.

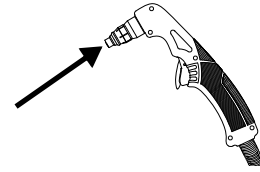

Inspect the consumables for proper installation and wear.

Every 3 months:



Replace any damaged labels.

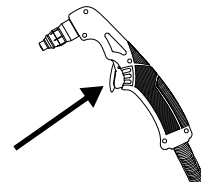

Inspect the trigger for damage. Inspect the torch body for cracks and exposed wires. Replace any damaged parts.

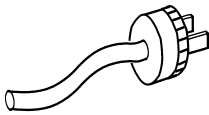

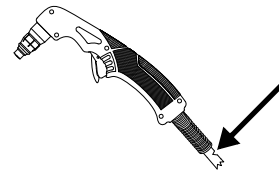

Inspect the power cord and plug. Replace if damaged.

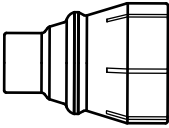

Inspect the torch lead. Replace if damaged.

Inspect the consumables

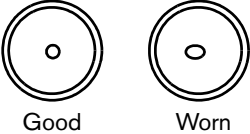
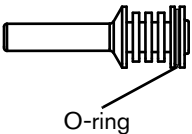
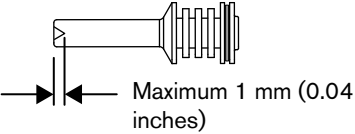
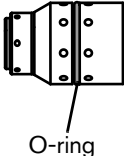
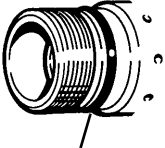
Part	Inspect	Action
 <p>Deflector*</p>	<p>The center hole for roundness. The rounded edges of the center hole for damage or noticeable wear.</p> <p>The gap between the nozzle and the deflector for accumulated debris.</p>	<p>Replace the deflector if the hole is no longer round or if it is worn or damaged.</p> <p>Remove the deflector and clean any material away.</p>
 <p>Nozzle</p>	<p>The center hole for roundness.</p>  <p>Good Worn</p>	<p>Replace if the center hole is not round. Replace the nozzle and the electrode together.</p>
 <p>Electrode</p>	<p>The center surface for wear and verify the pit depth.</p>  <p>Maximum 1 mm (0.04 inches)</p>	<p>Replace if the surface is severely worn or the pit depth is greater than 1 mm (0.04 inches) deep. Replace the nozzle and the electrode together.</p> <p>Do not apply grease or other lubricants to the O-ring on the electrode.</p>
 <p>Swirl ring</p>	<p>The internal surface for damage or wear and the gas holes for blockages.</p> <p>The length of the swirl ring.</p>	<p>Replace if the surface is damaged or worn or any of the gas holes are blocked.</p> <p>Do not apply grease or other lubricants to the O-ring on the swirl ring.</p> <p>If the length of the swirl ring is less than 21 mm (0.83 inches), replace it.</p>
 <p>Torch O-ring</p>	<p>The surface for damage, wear, or a lack of lubrication.</p>	<p>If the torch O-ring is dry, apply a thin film of silicone lubricant on the O-ring and the threads. The O-ring should look shiny, but there should not be any excess or built-up lubricant.</p> <p>If the O-ring is cracked or worn, replace it.</p>

* Initial Air T30 torches used deflectors made from anodized aluminum. These deflectors are now made from copper. Examine aluminum deflectors for signs of deformation. If necessary, replace them with the newer copper deflector.

Basic troubleshooting

The following sections provide an overview of the most common problems that may arise when using this system and explains how to solve them.

If you are unable to fix the problem by following this basic troubleshooting guide or if you need further assistance:

1. Call your Hypertherm distributor or authorized Hypertherm repair facility.
2. Call the nearest Hypertherm office listed in the front of this manual.



Power LED faults

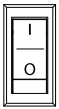

The ON/OFF power switch is set to ON (I), but the power ON LED does not illuminate.

- ❑ Make sure the power cord is plugged into the receptacle.
- ❑ Make sure the power is on at the main power panel or at the disconnect-power switch box.
- ❑ Make sure the line voltage is not too low (more than 15% below the rated voltage).



The power ON LED blinks.

- ❑ Have an electrical technician check the incoming power. The input line voltage is either too high or too low (a variance greater than $\pm 15\%$ of the rated voltage). See *Hypertherm system ratings* on page 17 and *Prepare the electrical power* on page 25.

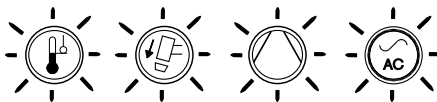

All four LEDs blink when the system is powered ON.

- ❑ A qualified service technician must service the system. Contact your distributor or use the information in the front of this manual to contact Hypertherm Technical Service.



Temperature LED faults



The temperature LED illuminates while the machine is powered ON.

- ❑ The system overheated. Leave the system on to allow the fan to cool the power supply.
- ❑ If the system's internal temperature approaches -30°C (-22°F), the temperature LED may illuminate. Move the system to a warmer location.



The temperature LED blinks while the machine is powered ON.

- ❑ Leave the system on to allow the fan to cool the power supply. The temperature LED blinks when the system continuously draws too much input current for too long. Try the following to prevent this condition:
 - Turn down the cutting current. See *Step 3 – Adjust the output current* on page 43.
 - Operate the system on a 240 VAC input circuit whenever possible.
 - Avoid stretching the arc. Drag the torch on the workpiece. See *Edge start on a workpiece* on page 50.
 - Operate the system without using an extension cord. If you must use an extension cord, use a heavy conductor cord of the shortest possible length. See *Extension cord recommendations* on page 29.
 - Make sure nothing else is drawing power on the same circuit.



Internal compressor LED faults



The internal compressor LED and the temperature LED illuminate while the machine is powered ON.

- ❑ The internal compressor may have overheated. Allow the power supply to cool for 4 minutes before using it again. (See *Understand duty-cycle limitations* on page 46.)

When the internal compressor overheats, the compressor and temperature LEDs remain illuminated for 4 minutes.



The system does not prevent you from firing the torch before the 4 minutes elapses. However, if you begin cutting before the compressor has time to fully cool down, the same fault is likely to occur again.

- ❑ Place the power supply right-side up on a level surface. Laying the power supply on its side can prevent proper air circulation needed to cool internal components. It can also cause the air filter to divert air away from the torch.
- ❑ Inspect and replace the consumables if they are worn or damaged. Always replace the nozzle and electrode together. See *Inspect the consumables* on page 55.
- ❑ Was the system stored in temperatures below freezing? If so, ice might have formed inside the power supply. Move the power supply to a warmer location to allow the ice to melt.
- ❑ If none of these troubleshooting steps resolves the issue, a qualified service technician must service the system. Contact your distributor or use the information in the front of this manual to contact Hypertherm Technical Service.



The internal compressor LED and the temperature LED blink alternately when the machine is powered ON.



- ❑ Release the trigger and restart the power supply. The system automatically disables itself when the power supply is turned on while the torch trigger is pulled.



Torch LED faults

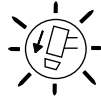

The torch cap LED illuminates or blinks while the machine is powered ON.

- ❑ Inspect the torch lead. If it is twisted or kinked, straighten it out and try to fire the torch again.
- ❑ Turn OFF (O) the power supply. Make sure the consumables are properly installed and tightened. See *Step 1 – Install the consumables* on page 41.
- ❑ If the consumables became loose or were removed while the power supply was ON, turn OFF (O) the power supply, correct the problem, and then turn ON (I) the power supply to clear the fault.
- ❑ If the consumables appear to be installed correctly, the torch may be damaged. Contact your Hypertherm distributor or authorized repair facility.



The internal compressor, temperature, and power ON LEDs blink, and the torch cap LED illuminates.

- ❑ Install new consumables in the torch (they may be corroded or approaching end of life).
- ❑ If you continue to see this error, contact your Hypertherm distributor or authorized repair facility.

Common cutting issues

Problem	Solution
The circuit breaker trips while you are cutting.	<ul style="list-style-type: none">▪ Turn down the cutting current. See <i>Step 3 – Adjust the output current</i> on page 43.▪ Operate the system on a 240 VAC input circuit whenever possible.▪ Avoid stretching the arc. Drag the torch on the workpiece. See <i>Edge start on a workpiece</i> on page 50.▪ Operate the system without using an extension cord. If you must use an extension cord, use a heavy conductor cord of the shortest possible length. See <i>Extension cord recommendations</i> on page 29.▪ Make sure nothing else is drawing power on the same circuit.
The cut quality is poor.	<ul style="list-style-type: none">▪ Make sure the torch is being used correctly. See <i>Hand torch operation</i> on page 48.▪ Make sure the correct consumables are installed. See <i>Consumable use</i> on page 33.▪ Inspect the consumables and replace as necessary. See <i>Inspect the consumables</i> on page 55.▪ Loosen the consumables about 1/8th of a turn and try again.▪ Make sure the work lead connection is secure and there is no damage to the work lead.▪ Operate the system without using an extension cord. If you must use an extension cord, use a heavy conductor cord of the shortest possible length. See <i>Extension cord recommendations</i> on page 29.
The torch does not cut completely through the workpiece.	<ul style="list-style-type: none">▪ Make sure the torch is being used correctly. See <i>Hand torch operation</i> on page 48.▪ Inspect the consumables and replace as necessary. See <i>Inspect the consumables</i> on page 55.
The arc does not transfer to the workpiece.	<ul style="list-style-type: none">▪ Clean the area where the ground clamp contacts the workpiece to ensure a good metal-to-metal contact.▪ Inspect the ground clamp for damage and repair it if necessary.▪ Move the torch closer to the workpiece and fire the torch again. See <i>Hand torch operation</i> on page 48.

Problem	Solution
<p>A small amount of moisture exits the torch nozzle.</p>	<ul style="list-style-type: none"> ▪ A small amount of moisture at the torch nozzle is normal for this system, particularly in very humid environments. It should not prevent the torch from firing or degrade cut quality or performance. ▪ If excess moisture exiting the torch does interfere with starting the torch or with cutting performance, contact your Hypertherm distributor or authorized repair facility.
<p>The arc blows out but re-ignites when the torch trigger is pulled again, or the arc sputters and hisses.</p>	<ul style="list-style-type: none"> ▪ First, inspect the consumables for signs of excess moisture. A small amount of moisture at the torch nozzle is normal for this system and should not prevent the torch from firing. If excess moisture is present, fire the torch approximately 5 times in succession. ▪ If firing the torch does not clear out the excess moisture, and the moisture exiting the torch does interfere with starting the torch or with cutting performance, contact your Hypertherm distributor or authorized repair facility. ▪ If the problem persists and excess moisture is not an issue, inspect and replace the consumable parts if they are worn or damaged. See <i>Inspect the consumables</i> on page 55.

Section 6

Parts

Use the part numbers and kit numbers in this section to order consumables, accessories, and external replacement parts for your power supply and hand torch.



For instructions on installing the consumables in the hand torch, see *Step 1 – Install the consumables* on page 41.

This system contains no customer serviceable parts inside the power supply or inside the hand torch. For assistance with repairing or replacing internal components:

1. Call your Hypertherm distributor or authorized Hypertherm repair facility.
2. Call the nearest Hypertherm office listed in the front of this manual.

Power supply parts

Exterior, front

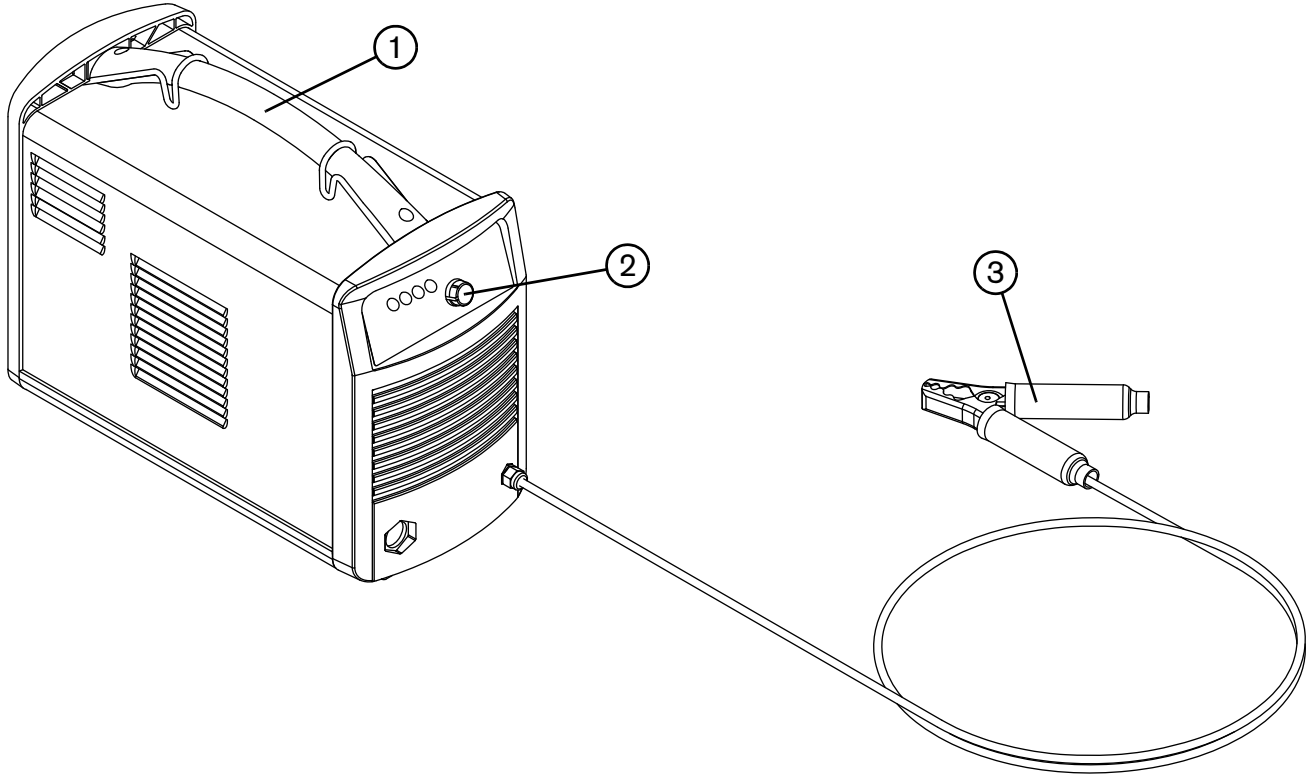

Item	Kit number	Description
1	228267	Kit: Power supply handle (includes screws and shoulder strap clips)
2	428226	Kit: Current adjustment knob
3	228561	Kit: Ground clamp

Exterior, rear

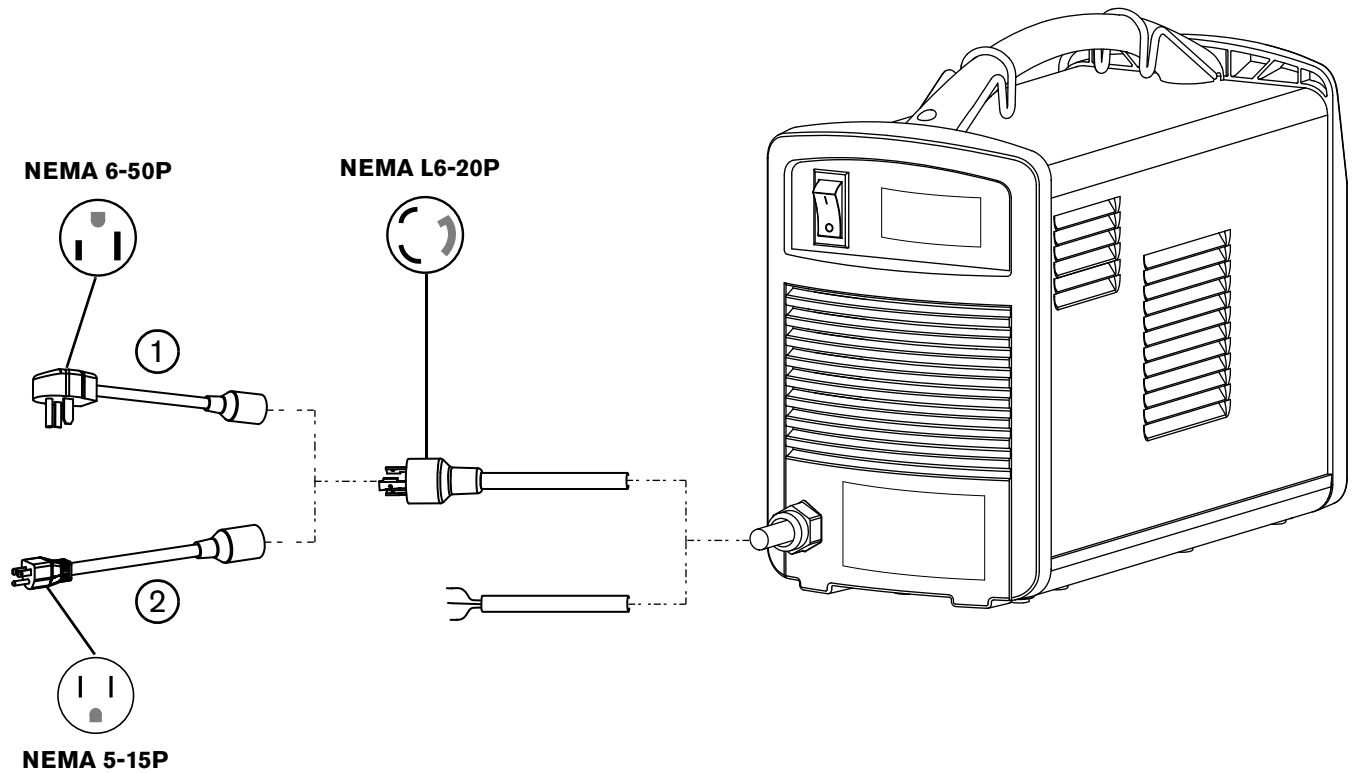

Item	Kit number	Description
1	229133	CSA power cord extension: 240 V / 20 A plug adapter
2	229132	CSA power cord extension: 120 V / 15 A plug adapter
	428392	Kit: Replacement bumpers (rubber "feet") for bottom of power supply (4) (not shown)

Hand torch consumables

To order consumables for your Air T30 torch, use the following part numbers.

You can order individual packages of nozzles and electrodes, or you can order them combined as a kit:

- Use **420134** to order a package of 5 nozzles.
- Use **420132** to order a package of 5 electrodes.
- Use **428350** to order a kit of 2 nozzles and 2 electrodes.



These consumables are designed specifically for use with the Powermax30 AIR power supply and Air T30 hand torch. They cannot be used with any other Powermax system or torch.

Individual consumables

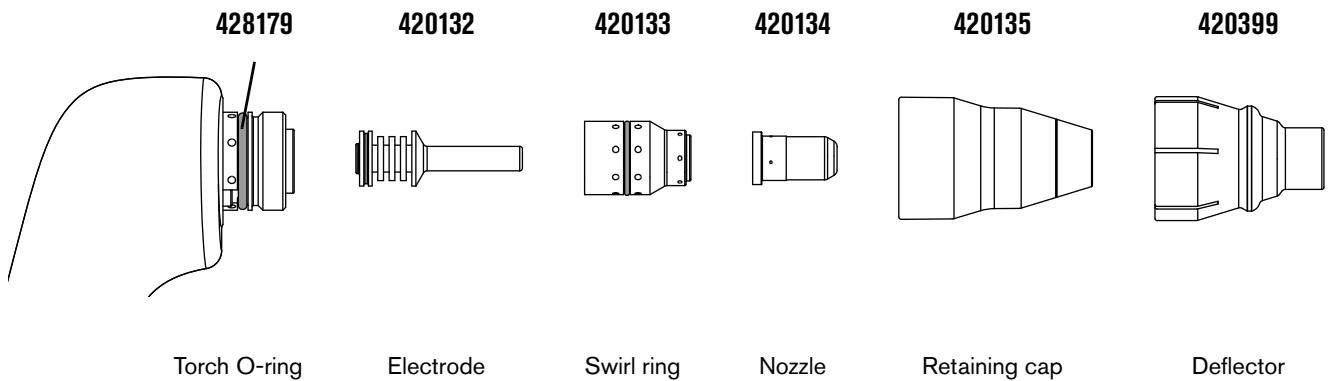

Kit: electrode (2) + nozzle (2)

428350

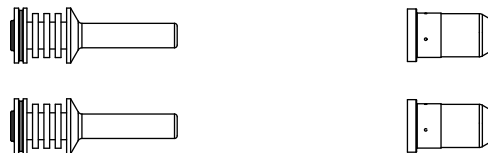

Accessory parts

Part number	Description
127102	Basic plasma (circle) cutting guide
027668	Deluxe plasma (circle) cutting guide
127144	Dust cover
024877	Leather torch lead cover, black with Hypertherm logo, 7.6 m (25 feet)
127217	Shoulder strap
127169	Leather cutting gloves
127416	Protective glasses, shade 5 lens

Power supply labels

Kit number	Description
428408	Kit: Powermax30 AIR labels, CSA
428410	Kit: Powermax30 AIR labels, CSA, Built in America
428409	Kit: Powermax30 AIR labels, CE/CCC

The label kits include:

- Consumables label
- Appropriate warning labels
- Front and side decals

The following illustrations show the consumables label and warning labels.





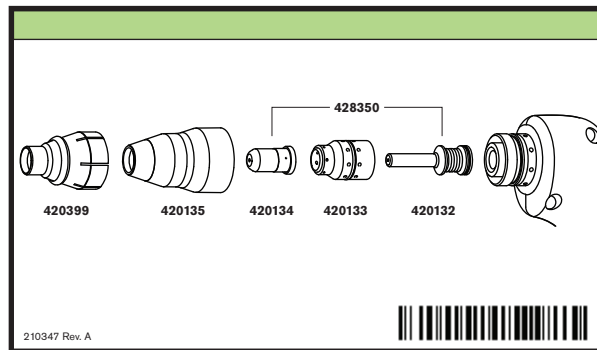







Consumables label

The consumables label is affixed to the power supply's rear panel. It shows the correct consumables to use with this system and torch and how to install them.



CSA warning label

This warning label is affixed to some power supplies. It is important that the operator and maintenance technician understand the intent of these warning symbols as described.

 Read and follow these instructions, employer safety practices, and material safety data sheets. Refer to ANS Z49.1, "Safety in Welding, Cutting and Allied Processes" from American Welding Society (http://www.aws.org) and OSHA Safety and Health Standards, 29 CFR 1910 (http://www.osha.gov).		 WARNING		 AVERTISSEMENT	
<p>1</p> 		<p>1.1 Do not cut near flammables.</p> <p>1.2 Have a fire extinguisher nearby and ready to use.</p> <p>1.3 Do not use a drum or other closed container as a cutting table.</p>		<p>1. Les étincelles de coupage peuvent provoquer une explosion ou un incendie.</p> <p>1.1 Ne pas couper près des matières inflammables.</p> <p>1.2 Un extincteur doit être à proximité et prêt à être utilisé.</p> <p>1.3 Ne pas utiliser un fût ou un autre contenant fermé comme table de coupage.</p>	
<p>2</p> 		<p>2.1 Turn off power before disassembling torch.</p> <p>2.2 Do not grip the workpiece near the cutting path.</p> <p>2.3 Wear complete body protection.</p>		<p>2. L'arc plasma peut blesser et brûler; éloigner la buse de soi. Il s'allume instantanément quand on l'amorce.</p> <p>2.1 Couper l'alimentation avant de démonter la torche.</p> <p>2.2 Ne pas saisir la pièce à couper de la trajectoire de coupage.</p> <p>2.3 Se protéger entièrement le corps.</p>	
<p>3</p> 		<p>3.1 Wear insulating gloves. Replace gloves when wet or damaged.</p> <p>3.2 Protect from shock by insulating yourself from work and ground.</p> <p>3.3 Disconnect power before servicing. Do not touch live parts.</p>		<p>3. Tension dangereuse. Risque de choc électrique ou de brûlure.</p> <p>3.1 Porter des gants isolants. Remplacer les gants quand ils sont humides ou endommagés.</p> <p>3.2 Se protéger contre les chocs en s'isolant de la pièce et de la terre.</p> <p>3.3 Couper l'alimentation avant l'entretien. Ne pas toucher les pièces sous tension.</p>	
<p>4</p> 		<p>4.1 Do not inhale fumes.</p> <p>4.2 Use forced ventilation or local exhaust to remove the fumes.</p> <p>4.3 Do not operate in closed spaces. Remove fumes with ventilation.</p>		<p>4. Les fumées plasma peuvent être dangereuses.</p> <p>4.1 Ne pas inhaler les fumées.</p> <p>4.2 Utiliser une ventilation forcée ou un extracteur local pour dissiper les fumées.</p> <p>4.3 Ne pas couper dans des espaces clos. Chasser les fumées par ventilation.</p>	
<p>5</p> 		<p>5.1 Wear correct and appropriate protective equipment to protect head, eyes, ears, hands, and body. Button shirt collar. Protect ears from noise. Use welding helmet with the correct shade of filter.</p>		<p>5. Les rayons d'arc peuvent brûler les yeux et blesser la peau.</p> <p>5.1 Porter un bon équipement de protection pour se protéger la tête, les yeux, les oreilles, les mains et le corps. Boutonner le col de la chemise. Protéger les oreilles contre le bruit. Utiliser un masque de soudeur avec un filtre de nuance appropriée.</p>	
<p>6</p> 		<p>6. Become trained. Only qualified personnel should operate this equipment. Use torches specified in the manual. Keep non-qualified personnel and children away.</p>		<p>6. Suivre une formation. Seul le personnel qualifié a le droit de faire fonctionner cet équipement. Utiliser exclusivement les torches indiquées dans le manuel. Le personnel non qualifié et les enfants doivent se tenir à l'écart.</p>	
<p>7</p> 		<p>7. Do not remove, destroy, or cover this label. Replace if it is missing, damaged, or worn.</p>		<p>7. Ne pas enlever, détruire ni couvrir cette étiquette. La remplacer si elle est absente, endommagée ou usée.</p>	
<p> WARNING: This product can expose you to chemicals including lead and lead compounds, which are known to the State of California to cause cancer and birth defects or other reproductive harm. For more information go to www.p65warnings.ca.gov.</p>		<p>AVERTISSEMENT : Ce produit peut vous exposer à des produits chimiques, dont le plomb et des composés de plomb, reconnus par l'État de la Californie comme cause de cancer et d'anomalie congénitale ou d'autres anomalies de l'appareil reproducteur. Pour obtenir de plus amples renseignements, consultez le www.p65warnings.ca.gov.</p>			

CE/CCC warning label

This warning label is affixed to some power supplies. It is important that the operator and maintenance technician understand the intent of these warning symbols as described. The numbered text corresponds to the numbered boxes on the label.



1. Cutting sparks can cause explosion or fire.
 - 1.1 Do not cut near flammables.
 - 1.2 Have a fire extinguisher nearby and ready to use.
 - 1.3 Do not use a drum or other closed container as a cutting table.
2. Plasma arc can injure and burn; point the nozzle away from yourself. Arc starts instantly when triggered.
 - 2.1 Turn off power before disassembling torch.
 - 2.2 Do not grip the workpiece near the cutting path.
 - 2.3 Wear complete body protection.
3. Hazardous voltage. Risk of electric shock or burn.
 - 3.1 Wear insulating gloves. Replace gloves when wet or damaged.
 - 3.2 Protect from shock by insulating yourself from work and ground.
 - 3.3 Disconnect power before servicing. Do not touch live parts.
4. Plasma fumes can be hazardous.
 - 4.1 Do not inhale fumes.
 - 4.2 Use forced ventilation or local exhaust to remove the fumes.
 - 4.3 Do not operate in closed spaces. Remove fumes with ventilation.
5. Arc rays can burn eyes and injure skin.
 - 5.1 Wear correct and appropriate protective equipment to protect head, eyes, ears, hands, and body. Button shirt collar. Protect ears from noise. Use welding helmet with the correct shade of filter.
6. Become trained. Only qualified personnel should operate this equipment. Use torches specified in the manual. Keep non-qualified personnel and children away.
7. Do not remove, destroy, or cover this label. Replace if it is missing, damaged, or worn.